

University of East London Institutional Repository: <http://roar.uel.ac.uk>

This paper is made available online in accordance with publisher policies. Please scroll down to view the document itself. Please refer to the repository record for this item and our policy information available from the repository home page for further information.

Author(s): Saidpour, Hossein; Abessalam, Qutaiba

Title: Influence of coupling agents on tensile properties of natural fibre composites

Year of publication: 2010

Citation: Saidpour, H. and Abessalam, Q. (2010) 'Influence of coupling agents on tensile properties of natural fibre composites.', Proceedings of Advances in Computing and Technology, (AC&T) The School of Computing and Technology 5th Annual Conference, University of East London, pp.86-93.

INFLUENCE OF COUPLING AGENTS ON TENSILE PROPERTIES OF NATURAL FIBRE COMPOSITES

Hossein Saidpour and Qutaiba Abessalam

s.h.saidour@uel.ac.uk, salam4me4@hotmail.com

*School of Computing, Information Technology and Engineering,
University of East London*

Abstract: In This study was carried out to investigate the effects of the silane coupling agent on the mechanical properties of the fruit pits powder, reinforced epoxy composites. The choice of the coupling agent has a significant effect on the fibre-matrix interfacial properties of the composites and this paper aims to present results of the investigation together with the relevant discussion on the way in which the properties have been enhanced by the use of coupling agents.

1. Introduction

Many different natural fibres are profitably used in the manufacture of fibre polymer reinforced composites because they possess attractive physical and mechanical properties (Cazaurang-Martínez 1991). They impart the composite high specific stiffness and strength, a desirable fibre aspect ratio, biodegradability, they are readily available from natural sources and more importantly they have a low cost per unit volume basis. It should also be mentioned that the hollow nature of vegetable fibres may impart acoustic insulation or damping properties to certain types of matrices. Unlike the traditional engineering fibres, e.g. glass and carbon fibres, along with mineral fillers, these lignocellulosic fibres are able to impart the composite certain benefits such as: low density; less machine wear than that produced by mineral reinforcements; no health hazards; and a high degree of flexibility. The later is especially true because these fibres unlike glass fibres will bend rather than fracture during processing. Whole natural fibres undergo some breakage

while being intensively mixed with the polymeric matrix, but this is not as notorious as with brittle or mineral fibres.

One difficulty that has prevented a more extended utilization of the natural fibres is the lack of a good adhesion to most polymeric matrices. The hydrophilic nature of natural fibres adversely affects adhesion to a hydrophobic matrix and as a result, it may cause a loss of strength. To prevent this, the fibre surface has to be modified in order to promote adhesion. Several methods to modify the natural fibre surface have been proposed: the graft copolymerization of monomers onto the fibre surface, the use of maleic anhydride copolymers, alkyl succinic anhydride, stearic acid, etc. It has also been reported that the use of coupling agents such as silanes, titanates, zirconates, triazine compounds, etc. also improve fibre-matrix adhesion. Furthermore, it is also known that pre impregnation of the fibre with the polyolefin solution will also improve adhesion (Valadez-Gonzalez A 1999).

Many types of coupling agents have been used by many researchers to improve the mechanical properties of natural fibre composites. Salem et al (2006) attempted to

study the chemical properties of the fruit pit waste and they also studied its nutritive elements.

According to them the most important elements in the fruit pits were the cellulose, hemicelluloses, and lignine:

- cellulose 33–42%
- hemi-celluloses 35–43%
- lignine 15–23%

Oreganofunctional silanes are the most widely used coupling agents used to improve the interfacial adhesion between fibres/ matrix in reinforced materials. Their effectiveness depends on the natural fibres, per-treatment of the substrate, the type of silane used, the thickness of the silane layer and method by which it is applied.

In a relatively dry state the proper choice of a silane coupling agent is an effective means of encouraging interfacial adhesion and appealing mechanical properties. Under wet conditions, however, its effectiveness depends considerably on the nature of the chemical bond between the silane coupling agent and the primary constituents. A selection of mechanisms have been planned to explain the function of silane at the interface.

DiBenedetto et al (2001) were the first to do a systematic study of the effectiveness of over a hundred silane coupling agents on the wet strength of epoxy and polyester laminates. This data along with collected data suggested that the primary factors are:

1. the chemical reactivity of the Oreganofunctional group of the silane forms a covalent bond with the polymer matrix
2. the primary or secondly chemical bond formation at the fibre interface

The ability of the polymer matrix to spread into the silane to shape a rigid, tough, water resistant interpenetrating polymer network

as a transition zone between the bulk matrix and the fibre reinforcement

Gassan et al (1998) studied the effect of coupling agents on the performance of natural fibres specifically with the cellulose, hemi-celluloses and the lignin cellulose.

The main concept for the function of polymer-silane-natural fibres based on the vision of Gassan, is shown in the Figure 1 and 2. Treatment of cellulose fibres with hot polypropylene–maleic anhydride (MAH–PP) copolymers provides covalent bonds across the interface. This provides a means of minimizing stress concentrations at the interface between the two elements of vastly different stiffness is provided by the breaking and reforming of the hydrogen bond while maintaining molecular contact beneath the rigid silane network.

In this paper, a study of the degree of the mechanical reinforcing capability of crushed fruit pits powder, considered to be short fibres, can be achieved by different fibre surface treatments and the optimisation of the process is presented. A simple epoxy matrix and two levels of fibre-matrix adhesion were chosen. First, untreated fruit pits powder for poor fibre-matrix adhesion is analysed, and second, a higher degree of adhesion by chemical interaction between a silane treated fibre and the matrix is promoted in order to improve the fibre-matrix interaction. The reinforcing efficiency is assessed by comparing with composite stiffness values calculated by the rule of mixtures.

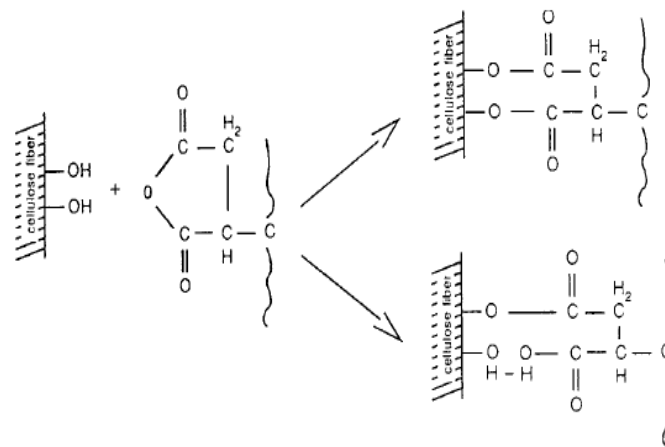

Figure 25 Treatment of cellulose fibres with hot polypropylene–maleic anhydride (Gassan, 1998)

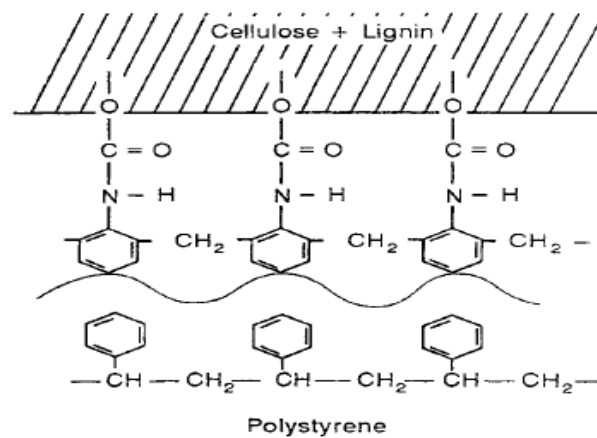

Figure 26 Concept of a polymer/Siloxane/Cellulose +Lignin Interphase (Gassan, 1998).

2. Experimental details

2.1 Materials

Materials used during this investigation are:

- Crushed fruit pits powder supplied by Abdul Kareem Abdul Salam Co. Syria, which consisted of a light yellow soft powder with a fibre size of 0.1-0.6 mm. Figure 6 shows an SEM picture of a fibre sample.
- 3-aminopropyltriethoxysilane coupling agent 99% purity supplied by Silane Co.
- MY 750 epoxy resin with HY 1300 hardener supplied by Robnor Resin Ltd.

2.2 Preparation of samples and testing

The fruit pits powder was pre-treated with a solution of 98% acetone and 1.5% coupling agent, the matrix- catalyst mixture was carefully added to the treated fruit pits powder.

The matrix-powder mixture was then poured into a flat mould and then cured for 24 hours. Two kinds of sample were made, 1) untreated fruit pit powder composites 2) pre-treated powder epoxy composites. Figures 7 and 8 show the microscope images of the fruit pits powder treated with coupling agents.

Tensile testing was carried out on all samples according to the BS EN 2747:1998 standard for testing.

3. Results and discussion

3.1 Tensile Strength and Modulus

Summarised tensile test results of the samples including different percentages of the fruit pits powder reinforcement are presented in Table 1 with average values obtained from three samples. The amount of

powder in each category includes 10%, 20% and 30% by weight. This table shows the ultimate tensile strength (UTS), Young's modulus and strain to failure values.

Figure 1 shows the stress - strain curves of all the composite samples which shows the behaviour of the different composite materials, including the effects of coupling agent and weight fraction of the powder under tensile loading.

The results indicate that the tensile strength and modulus gradually increases with increasing fibre content, most notably in the range of 0.10 to 0.40 fibre weight fraction. The increasing trend in the tensile strength and tangent modulus shows a direct correlation between fibre weight fraction and tensile strength and stiffness.

Comparison between the samples of treated and untreated powder with different weight fractions (10%, 20% and 30%) shows that the tensile strength and modulus increases when the treated fibre is used, as indicated in Figures 5-6.

When the untreated powder is used the highest tensile strength is achieved with 30% fibre weight fraction. On the other hand when treated powder is used in the composites the highest value of strength and modulus was achieved for 30% and 20% fibre weight fractions respectively. Furthermore the highest and the lowest tensile strength values have been achieved with 29 MPa and 13.1 MPa for 30% with treated fibre and 0% fibre weight fractions respectively. This indicates a 121% increase in strength when the optimum amount of treated fibre is used. Any higher amount of fibre reinforcement leads to deterioration of both tensile and modulus values. This is due to the fact that when higher percentage of fibre is used in the composite the resulting matrix resin may not be enough to completely impregnate or wet-out the fibres.

Table 1 Results of the tensile testing for the composites with different filler loadings

Amount of filler (w/w%)	UTS (MPa)		Strain to failure		Modulus (MPa)
	Mean	SD	Mean	SD	
0.0	13.09	0.20	0.0907	0.0015	438.7
0.10	16.53	0.15	0.0843	0.0034	275.2
0.20	17.8	0.25	0.0843	0.0020	399.5
0.30	25.07	0.30	0.0889	0.0019	363.8
0.10*	18.628	0.18	0.0468	0.0021	702.0
0.20*	21.61	0.23	0.0505	0.0017	753.0
0.30*	28.998	0.19	0.0629	0.0024	675.9
0.46*	17.584	0.45	0.05688	0.0023	532.0

* Treated filler

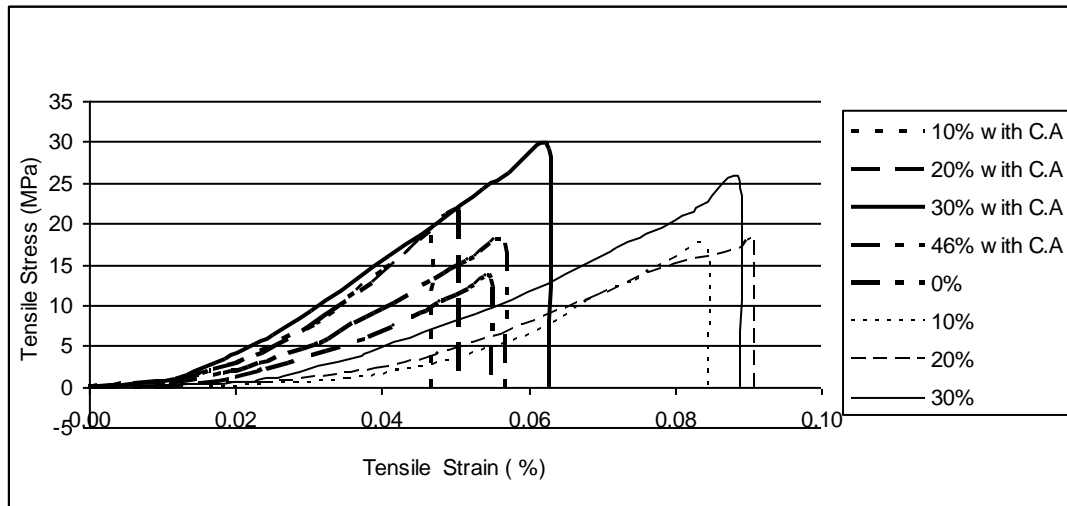

Figure 1 Tensile test results for the fruit pit powder reinforced epoxy composites

Therefore this may lead to matrix starvation or dry powder in the composites which consequently leads to reduced mechanical properties of the composites. The results also show that the process of fibre treatment with coupling agent can have a significant influence on the mechanical properties. It can be seen from Figure 6 that the modulus values of the samples with 10% fibre weight fraction increases from 275 MPa to 752 Mpa for untreated and treated powder composites respectively. This indicates an improvement of nearly 173 % in the Young's modulus. This is due to the improvement in the fibre- matrix interfacial interaction.

However when the effect of coupling agent on tensile strength is considered, the improvement has been found to be approximately 14% in all the different powder weight fraction categories. This shows that regardless of the amount of reinforcement in the matrix a uniform increase in properties is achieved when the powder is pre-treated with the coupling agent.

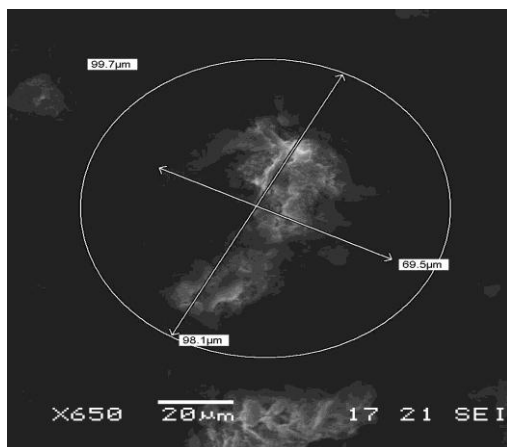

Figure 2 Scanning electron micrograph ($\times 650$) showing dimensions of a typical fibre taken from the fruit pits powder.

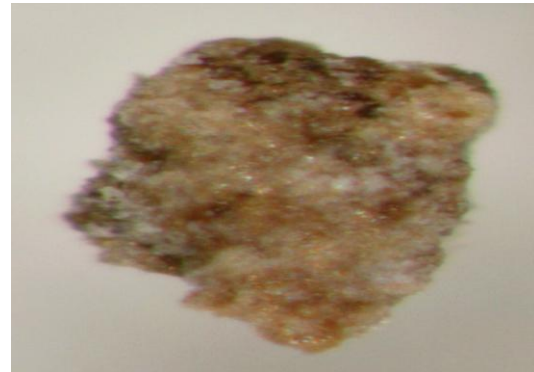

Figure 3 Optical microscope image of the untreated crushed fruit pits powder



Figure 4 optical microscope image of the treated crushed fruit powder

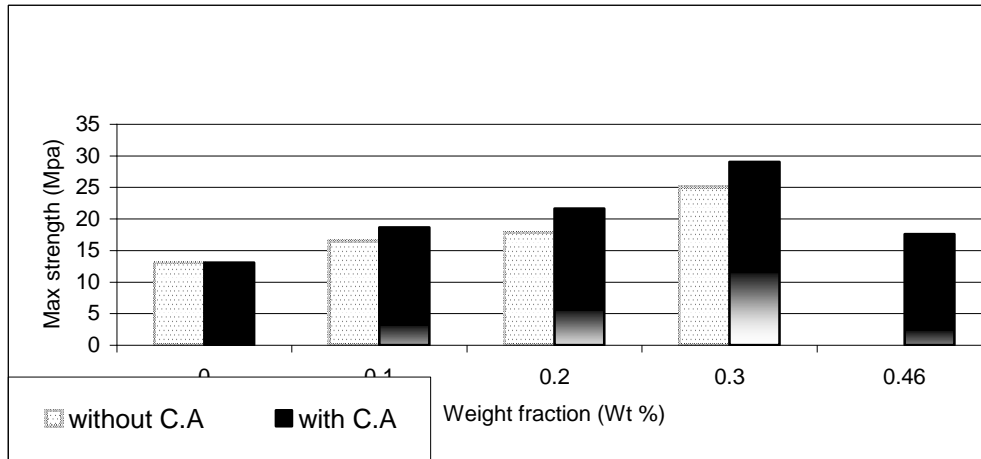

Figure 5 Relationship between the powder weight fraction and the UTS of the composites

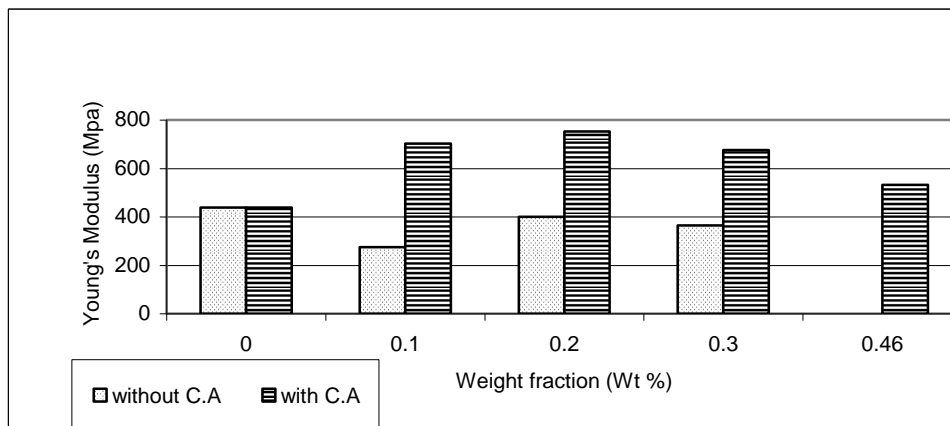

Figure 6 Effect of coupling agent treatment of powder and powder weight fraction on the modulus of composites

3. Conclusions

It has been shown that the treatment of the crushed fruit pits powder with a suitable coupling agent has improved the performance of the powder- epoxy composites under tensile loading conditions. It is proposed that the future research direction should concentrate on more detailed mechanical testes such as the impact , flexural, DMA and DSC testes to examine the behaviour of the composites (with and without coupling agent treatment).

4. References

- Bledzki, A.K., Gassan, J.. (1998). Composites reinforced with cellulose based fibres. *Elsevier*. 24 (3), 221–274
- British Standards Institution , BS EN 2747: 1998 tensile test .
- Cazaurang-Martínez MN, Herrera-Franco PJ, González-Chi PI, Aguilar-Vega M. (1991) Physical and mechanical properties of of henequen fibres. *J Appl Polym Sci*; 43:749–56.
- DiBenedetto, A.T.(2001)"Tailoring of interfaces in glass fibre reinforced polymer composites: a review", *Materials Science & Engineering A*
- Gironès, J. , Pimenta, M.T.B., Vilaseca, F. , de Carvalho, A.J.F., Mutjé, P.,and Curvelo, A.A.S., (2007) " Blocked isocyanates as coupling agents for cellulose-based composites" *Carbohydrate Polymers*, Volume 68, Issue 3, 5, Pages 537-543. April.
- Salem, Z., Lebig, H. , Cherafa, W.K., Allia, K. (2007). "Valorisation of fruit pits using biological identification". *Elsevier*,20,4,(1),72–78