

University of East London Institutional Repository: <http://roar.uel.ac.uk>

This paper is made available online in accordance with publisher policies. Please scroll down to view the document itself. Please refer to the repository record for this item and our policy information available from the repository home page for further information.

To see the final version of this paper please visit the publisher's website. Access to the published version may require a subscription.

Author(s): Wijeyesekera, D.Chitral; Reginold, J.T.

Article title: Mathematical and Physical Study of Pipe Lines Subjected to Differential Ground Movement

Year of publication: 2007

Citation: Wijeyesekera, D.C; Reginold, J.T. (2007) 'Mathematical and Physical Study of Pipe Lines Subjected to Differential Ground Movement' Proceedings of the AC&T, pp.243-251

Link to published version:

<http://www.uel.ac.uk/act/proceedings/documents/ACT07.pdf>

MATHEMATICAL AND PHYSICAL STUDY OF PIPE LINES SUBJECTED TO DIFFERENTIAL GROUND MOVEMENT

D. C. Wijeyesekera, J.T.Reginald

University of East London

D.C.Wijeyesekera **Error! Bookmark not defined.** @uel.ac.uk and *J.T. Reginald* @uel.ac.uk

Abstract: Soil-pipe interaction studies leading to the laboratory observations of the effects of differential ground movement between a heavy yielding structure and a pipeline firmly connected to it is presented in this paper. Such differential movements induce excessive stress concentrations on the pipeline. Plastics pipes fail as a consequence of such movements, though their flexibility should make them less vulnerable than rigid pipes. In order to evaluate the displacement, bending moment, shear force, vertical soil resistance at soil pipe interface under these conditions, innovative experimental techniques were developed and these are described in this paper. The soil resistance on a pipe section is characterised by the load-displacement behaviour of the embedded pipe section subjected to lateral displacement, vertical displacement, axial displacement along the axis of the pipe and rotation about the pipe axis. A mathematical analysis to complement the laboratory studies is developed and presented by treating the pipelines as a beam on elastic foundation. The magnitude and location of the maximum bending moments arising from yielding of the heavy structure is examined. The experimental observations of the behaviour of pipes subjected to such differential ground movement are compared with the results from the theoretical predictions. The provision of rocker pipe joints that entertain a permitted rotation helps to redistribute the adverse bending moments to acceptable levels and thereby alleviate distress in the pipeline. The paper gives results that demonstrate theoretically and experimentally the appropriateness of the use of flexibly jointed rocker pipes to prevent such failures. Field examples of the adoption of such joints is also presented and discussed culminating with the expression of the need for rational design procedures for pipeline foundations including rocker pipes to be incorporated into codes of practice such as EN 1295 is emphasised.

1. Introduction

The design of pipes due to various soil-pipe interaction effects has not developed at the same pace as the development of flexible pipe materials. Knowledge of the anticipated differential movements can be used to establish maximum levels of bending moment that can be accommodated by various pipelines. This paper presents physical and analytical modelling of such ground movements. Any unanticipated differential ground movements between a settling structure and a pipeline attached to it can further exacerbate the stresses in the pipeline to

unacceptable levels. Often such differential settlements that occur are not considered in the design and the pipeline fails even before it is fully commissioned. Olliff et al, 1994 raised the awareness for provision to be made for such differential settlements. The Materials Selection for Sewers, Pumping mains and Manholes (UK Water Industry Sewers and Water Mains Committee, 1996) suggested that the first joint should be within 150 mm of the face of the structure. Authors of this paper suggested the adoption of rocker pipes in Olliff et al, 2000. Subsequently, section 4.6.6 of the Sewers for adoption, 5th edition, 2001 recommended the need for a

flexible joint to be provided as close as feasible to the outside face of any structure in which a pipe is built. Furthermore, the next length of pipe (rocker pipe) away from the structure was recommended to be as shown in table 1.

Table 1 - Recommended rocker pipe length (modified from Sewers for adoption; 2001)

Nominal diameter mm	Effective length mm	Length to Diameter Ratio
150	600	4.0
<600-150	600	1.0
675	1000	1.5
<750-675	1000	1.3
>750	1250	1.7

Considering the pipeline as a beam on elastic foundation, the distribution of bending moments arising from the differential ground movement can be determined. The structural analysis for such a case is presented in the paper with particular emphasis on how adverse bending moment distributions can be alleviated through the provision of flexibly jointed rocker pipes. The analysis will give a more precise compatibility check to accommodate an anticipated differential movement with a flexible joint having a known capability of joint rotation.

2. Pipeline Flexibility near Settling Structure

When differential settlements occur between a structure and the connected buried pipeline the pipes will be subjected to longitudinal bending, and the joints to

shear and angular rotation. The length of the pipe section immediately adjacent to the structure must be designed to keep all of these considerations within allowable limits. A method of determining this appropriate length of pipe section is described. The method can be applied to pipes of differing materials with different types of joints.

2.1. Analytical Study:

Failure to design pipelines to accommodate, or avoid differential settlements is one of the more common causes of structural failure, and a design analysis should therefore be carried out for an evaluation of permissible bending moments.

A prismatic beam (figure 1) connected to a structure and supported continuously along its length by a foundation will experience elastic deformation. The resulting sub grade reaction can be assumed to be linearly proportional to the beam deflection at any point. Under such conditions the reaction per unit length of the beam can be represented by the expression $k_s y$, where y is the deflection and k_s is a constant usually called the modulus of the soil foundation. This constant denotes the reaction per unit length when deflection is equal to unity. This assumption helps in writing the stability equations that are amenable to solution. This represents an idealization closely approximating many real situations. Beam behaviour of pipeline is analysed according to the theory of beams on elastic foundations (Selvadurai, 1984), a theory validated by the results of many field studies and experiments (Olliff, 2003).

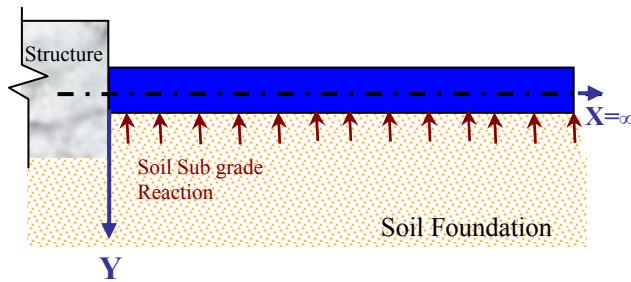

Figure 1. Semi-infinite beam on elastic foundation

In figure 1, x represents the location of the point from the settling structure, at which the bending moment is evaluated. The analysis presented here establishes the minimum length required to ensure that the allowable rotation of the flexible joint is not exceeded. Knowledge of this length aids in determining the bending moments in the rocker pipe and the shear forces at its ends. If these are excessive, they must be reduced to levels below the allowable limits. This cannot of course, be done by reducing the length of the ‘rocker pipe’, otherwise the joint rotation criteria would not be met.

The deformed shape of a beam on elastic foundation (Selvadurai, 1984) is given by the equation (1)

$$y = e^{\beta x} (A \cos \beta x + B \sin \beta x) + e^{-\beta x} (C \cos \beta x + D \sin \beta x) \dots \dots \dots (1)$$

For the particular problem illustrated in figure 1, the following boundary conditions apply:

For a semi infinite pipe (when $x > 150\text{mm}$) the deflection, y is zero. At the interface of the structure and the pipe ($x = 0$) the pipe

deflection will be the same as that of the settling structure (Δ) and the slope of the pipe will be zero.

The equation 1 then reduces to

$$y = \Delta e^{-\beta x} [\cos \beta x + \sin \beta x] \dots \dots \dots (2)$$

Differentiation of equation 2 gives the slope at x to be

$$y' = -2\Delta\beta e^{-\beta x} \sin \beta x \dots \dots \dots (3)$$

Differentiation of equation 3 gives the bending moment, M, at x;

$$M = 2EI\Delta e^{-\beta x} \beta^2 (\cos \beta x - \sin \beta x) \dots \dots \dots (4)$$

Differentiating the equation 4 then gives the shear force at x;

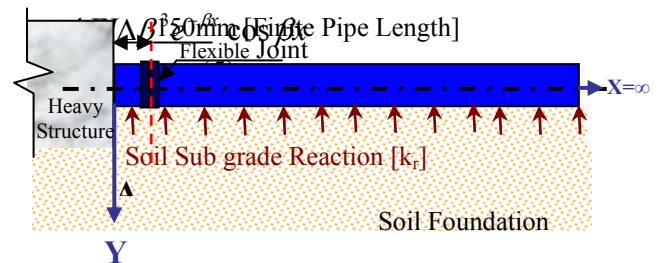

Figure 2. The location of first flexible joint

In the analysis for the location of the first flexible joint, the pipe length (AA^1) is considered to be finite.

For this particular case the corresponding equations become;

$$y = e^{\beta x} [A \cos \beta x + B \sin \beta x] + e^{-\beta x} [C \cos \beta x + D \sin \beta x] \dots \dots \dots (6)$$

$$y' = \beta e^{-\beta x} [-A(\cos \beta x + \sin \beta x) + B(\cos \beta x - \sin \beta x)]$$

$$+ \beta e^{\beta x} [-C(\sin \beta x - \cos \beta x) + D(\cos \beta x + \sin \beta x)]$$

(7)

$$y'' = 2\beta^2 e^{-\beta x} (A \sin \beta x - B \cos \beta x) + 2\beta^2 e^{\beta x} (-C \sin \beta x + D \cos \beta x)$$

..... (8)

$$y''' = 2\beta^3 e^{-\beta x} [A(\cos \beta x - \sin \beta x) + B(\sin \beta x + \cos \beta x)]$$

$$+ 2\beta^3 e^{\beta x} [-C(\cos \beta x + \sin \beta x) - D(\sin \beta x - \cos \beta x)]$$

..... (9)

For a 40mm diameter pipe, the solutions for the equations 6 to 9 are presented graphically in figures 3 and 4. The vertical displacement variations in figure 5 for the three pipe lengths of 1.5 and 3.0m are coincident. The maximum uplift (1.60 to 1.75mm) of the pipes occur at $x = 278 \pm 2$ mm (x/D of 2.2 to 5.5). These variations are very coincident and this is illustrated in Figures 3 and 4.

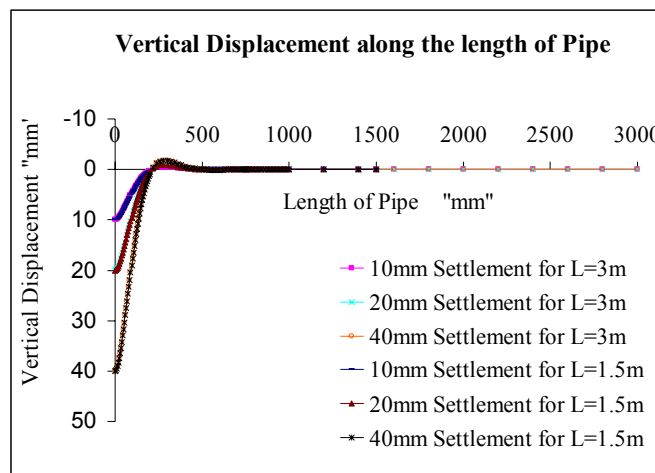

Figure 3. Vertical displacement variations for pipe lengths of 3m and 1.5m

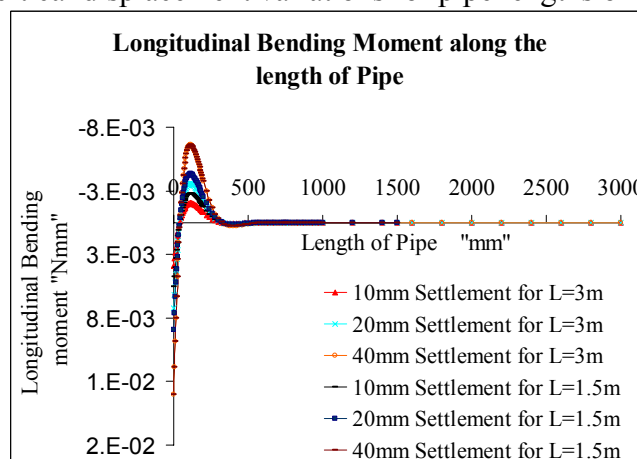

Figure 4. Variation of bending moment in pipe lengths of 3m and 1.5m

3. Rocker Pipe Design

The analysis described above established the minimum length required to ensure that the allowable joint rotation is not exceeded, and knowing this length, the bending moments in the rocker pipe, and

the shear forces at its ends, can be calculated. If these are excessive, they must be reduced by increasing the number of rocker pipes. Figures 5 and 6 compare the influence of one / two joints on the vertical displacement and bending moment profile respectively.

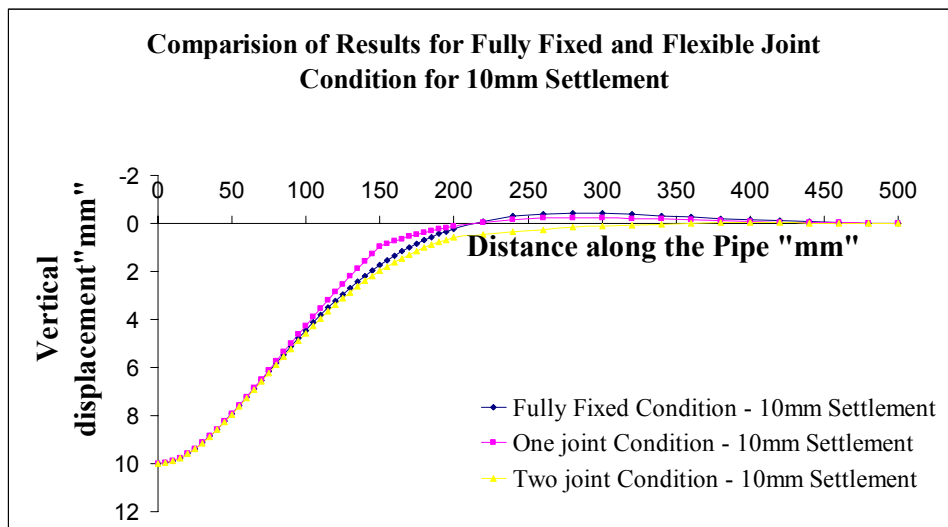

Figure 5. Influence of flexible rocker joint for varying settlement of 10mm.

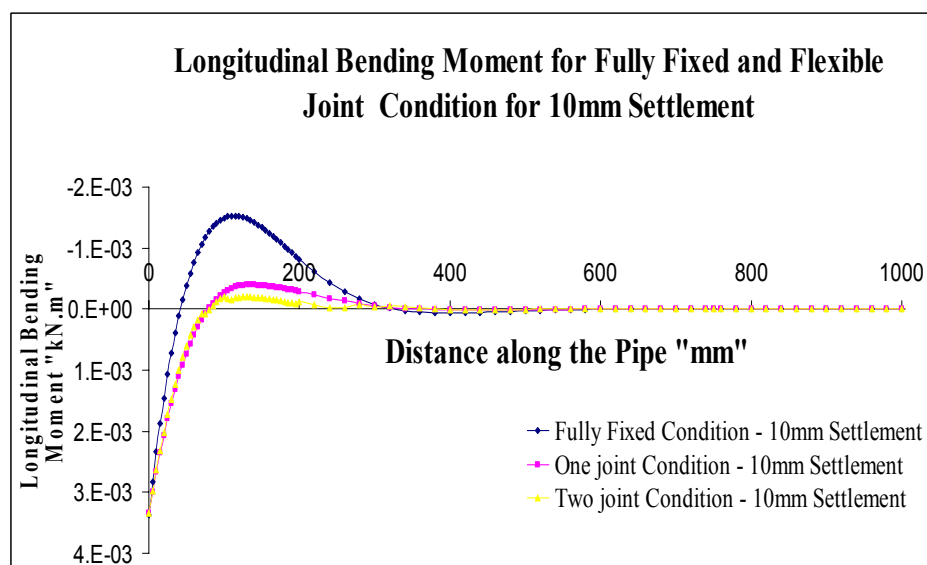

Figure 6. Influence of flexible rocker joints on bending moment for varying settlement of 10mm.

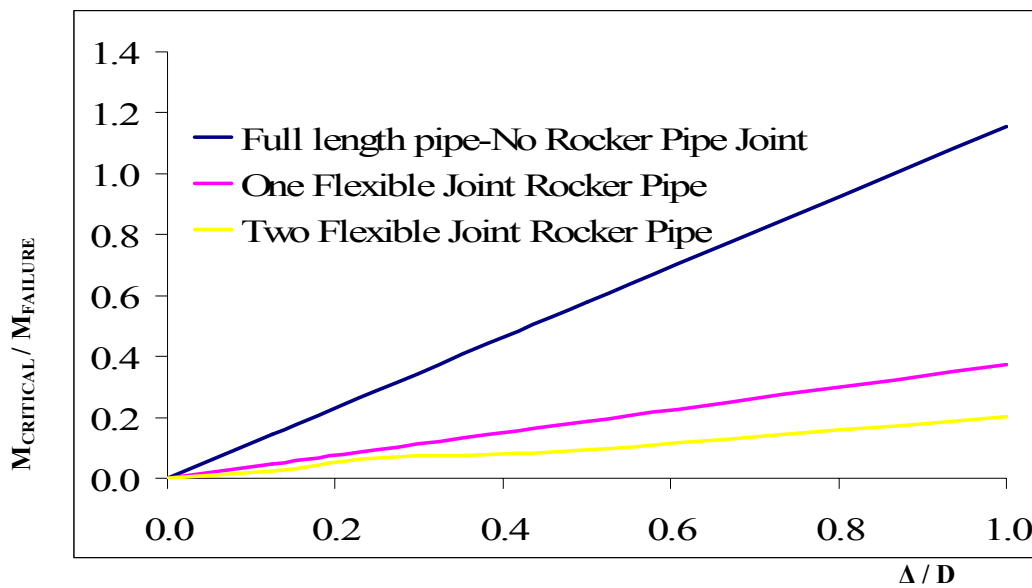

Figure 7. Rocker pipe joint design chart,

$M_{CRITICAL}$: Maximum bending moment

$M_{FAILURE}$: Bending moment at failure

Figure 7 is a design chart developed to facilitate the evaluation of the number of rocker pipes that need to be provided to meet an anticipated differential ground movement of Δ .

From the information available from the pipe/flexible joint manufactures and soil investigation for structural foundation, the design engineer can easily estimate the anticipated differential settlement. And the required number of flexible rocker pipe joints to accommodate the distress induced on connected pipeline due to differential settlement within the transition zone.

4. Physical modelling

Prototype field experiments to investigate the soil structure interaction can be very expensive. In this research programme, a series of laboratory soil box test with specially design and built loading frame is

used to induce settlement of the structure relative to the connecting pipeline (see figure 8). The objective of the laboratory research programme is to observe, evaluate and compare the mathematical predictions for the stress strain regimes around a pipe subjected to differential settlement.

The laboratory tests were carried out with small diameter plastic pipe generally used in the residential drainage connections. Literature research reviewed that such similar works are not carried out in the past to practically design the rocker pipe length.

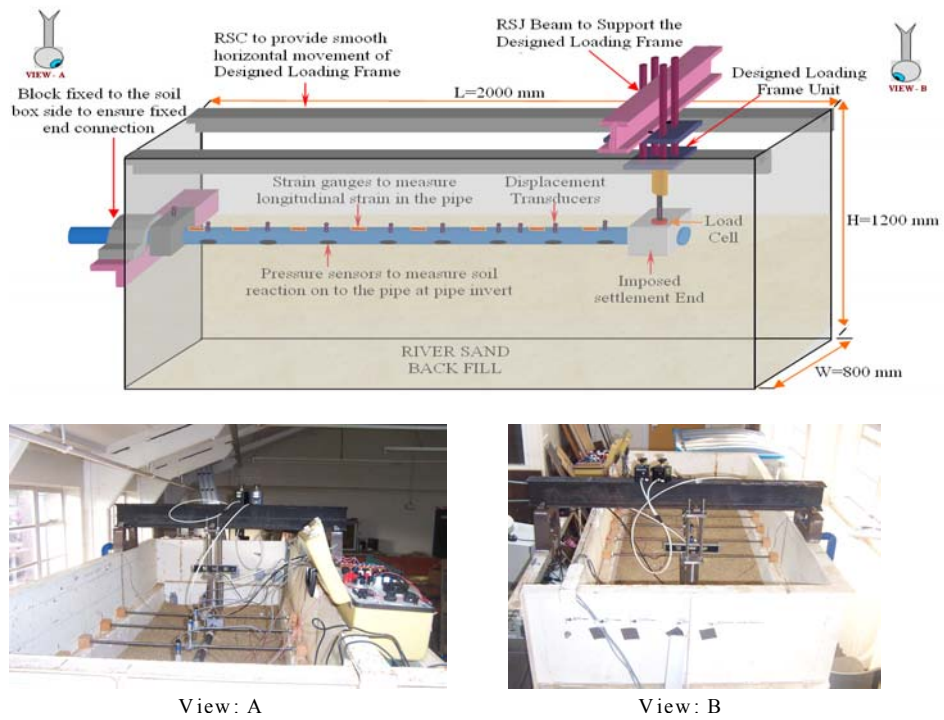

Figure 8. Soil Box used and instrumentation setup

4.1. Instrumentation and assumptions:

Thirty observations were monitored in the soil box experiments (see figure 9). Data logging was carried out using the

programmable data logging device to record observations from ten flexi force pressure sensors (PS), eleven linear displacement transducers (DS), one load cell (LC) and eight strain gauges (S).

Figure 9. Detailed Instrumentation along the length of the pipe

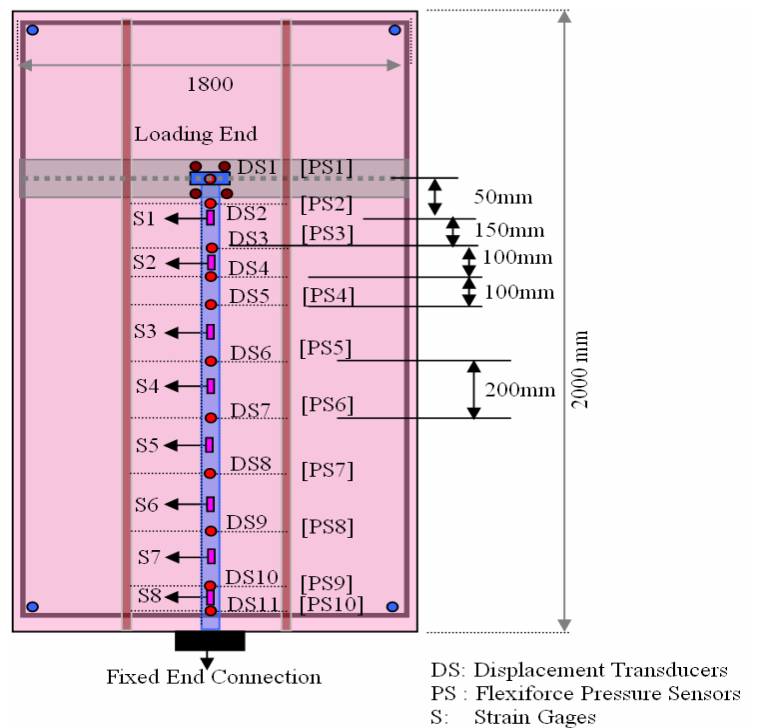

Following are the test assumptions made during the testing, observation and analysis:

Fixed Boundary conditions during soil box investigation. The pipe used in the soil box test is very flexible, and is not stiff enough to elongate laterally to exert horizontal thrust on the soil mass with decreasing vertical diameter.

A mathematical model for defining the soil pipeline interaction in response to differential settlement was described in section 2. The results of the physical full scale analysis described in this paper was compared further with the mathematical modelling outlined and referring to displacement from differential settlement and pipeline joint rotation/Rocker pipe is proposed , see figure 10.

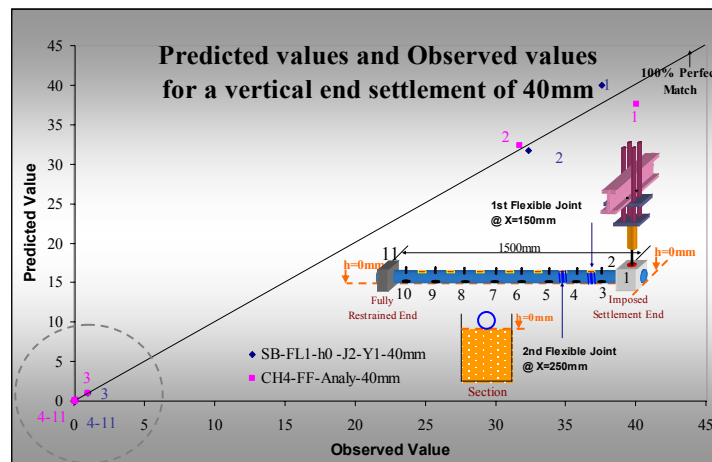

Figure 10. Compression of observed and predicted pipe deformation for a differential settlement of 40mm with two flexible rocker joints

5. Conclusions

The following conclusions can be drawn from the study

- Established pipeline design procedures frequently ignore or underestimate the settlements of soil masses, pipelines and structures.
- Analysis of pipelines as strip foundations can provide a useful estimate of likely settlements.
- Pipeline design should include analysis of settlements, and the provision of measures to limit them and/or enable the pipelines to accommodate their effects.

- The ability to accommodate settlements should be considered during the pipe material selection process.
- The effective modulus of a pipeline foundation will vary from place to place, reflecting inconsistencies in the placing and compaction of bedding material, variations in bedding thickness, and in sub-grade properties.
- The first flexible joint or rocker pipe needs to be within the first 150 mm from the yielding structure.
- If there is no provision in the form of rocker pipes made, a failure of the pipe can occur at a distance of 10 – 15 diameters from the face of the yielding structure.

6. References

1. Civil Engineering Specification for the Water Industry, 5th Edition, 2003.
2. Olliff J.L., Pipeline Foundation Design, Document C164/165/JWG1, CEN, December 1994.
3. Olliff J.L., Rolfe S., Wijeyesekera D.C., Reginold J.T., Soil Structure Pipe interaction with particular reference to ground movement induced failures, Plastic Pipes conference- xi, Germany 2000, pp 941-950.
4. Olliff J.L., Rolfe S., Wijeyesekera D.C., Reginold J.T., Settlement induced failures of plastic and other pipes, Plastic Pipes conference- xii, Italy 2003.
5. Rolfe S.J., The effects of Pipeline Settlement, World Water and Environmental Engineering, Vol 22, Issue 6, July 1999.
6. Wijeyesekera D.C., Reginold J.T., Rocker pipe- A solution for differential settlement induced distress in pipeline. ASME 6th International Pipeline Conference Proceeding IP2006,, Calgary, Canada September 2006.
7. Wijeyesekera D.C., Reginold J.T., Rocker pipe solution to alleviate differential settlement induced distress in flexible pipes. Advances in computing and technology Conference Proceeding AC&T2006,, London, United Kingdom, January 2006.
8. Reginold J.T., Rocker pipe solution to alleviate differential settlement induced distress in flexible pipes. Ph.D Thesis, University of East London, London, United Kingdom, September 2006.
9. Wijeyesekera D.C., Reginold J.T., Study of the use of rocker pipes to allow for differential ground movement in pipelines. Plastic Pipes conference- xiii, Washington DC, USA, October 2006.