

TATE & LYLE (LONDON) SPORTS & SOCIAL CLUB  
**TATE  
INSTITUTE**

# ***Over The Tracks***

*Outdoor Sugarcrete Furniture*

CONSTRUCTION WEEK 2023  
UNIVERSITY OF EAST LONDON

Sinan Aldulaymi  
Francesco Stefan  
Cristian Severin  
Shushant Jadhav  
Twinkle Shah  
Jason Tshibangu

06.11.2023



# PREFACE

We were provided a site in Silvertown, an area full of sugar trade and manufacturing heritage. To maintain this identity of the site and showcase to the masses what this area is known for, as well as for the benefit of the public and the environment, we opted to reclaim a public space and introduce, not only flora and fauna in a controlled manner, but also a flow of people who would enjoy the atmosphere our project would create. This project is a collaboration of students from the University of East London (UEL) and Newham 6th Form College (NewVIC), both in design and construction, making it both a social and technical engagement task. Over the Tracks (OTT) is a project led by Newham Council, working alongside the Royal Docks Learning and Activity Centre, with the with the end result being the establishment of a constantly growing community and a social space for it to grow in.

In response to this task, we designed and constructed a piece of outdoor furniture made up of almost entirely Sugarcrete®, that is easy to assemble and disassemble for transport and other purposes.

In addition to the Sugarcrete® seating acting as furniture, it is also used as a planter for vegetation suitable for its surrounding environment.



# TABLE OF CONTENTS

1. Brief	07
2. Site Analysis	08
3. Initial Design	10
4. Misconceptions	23
5. Final Design	24
6. Measurements	29
7. Mould Construction	36
8. Mixing and Casting Process	53
9. Demoulding and Reassembly	61
10. Final Outcome	66
11. Reflections	70



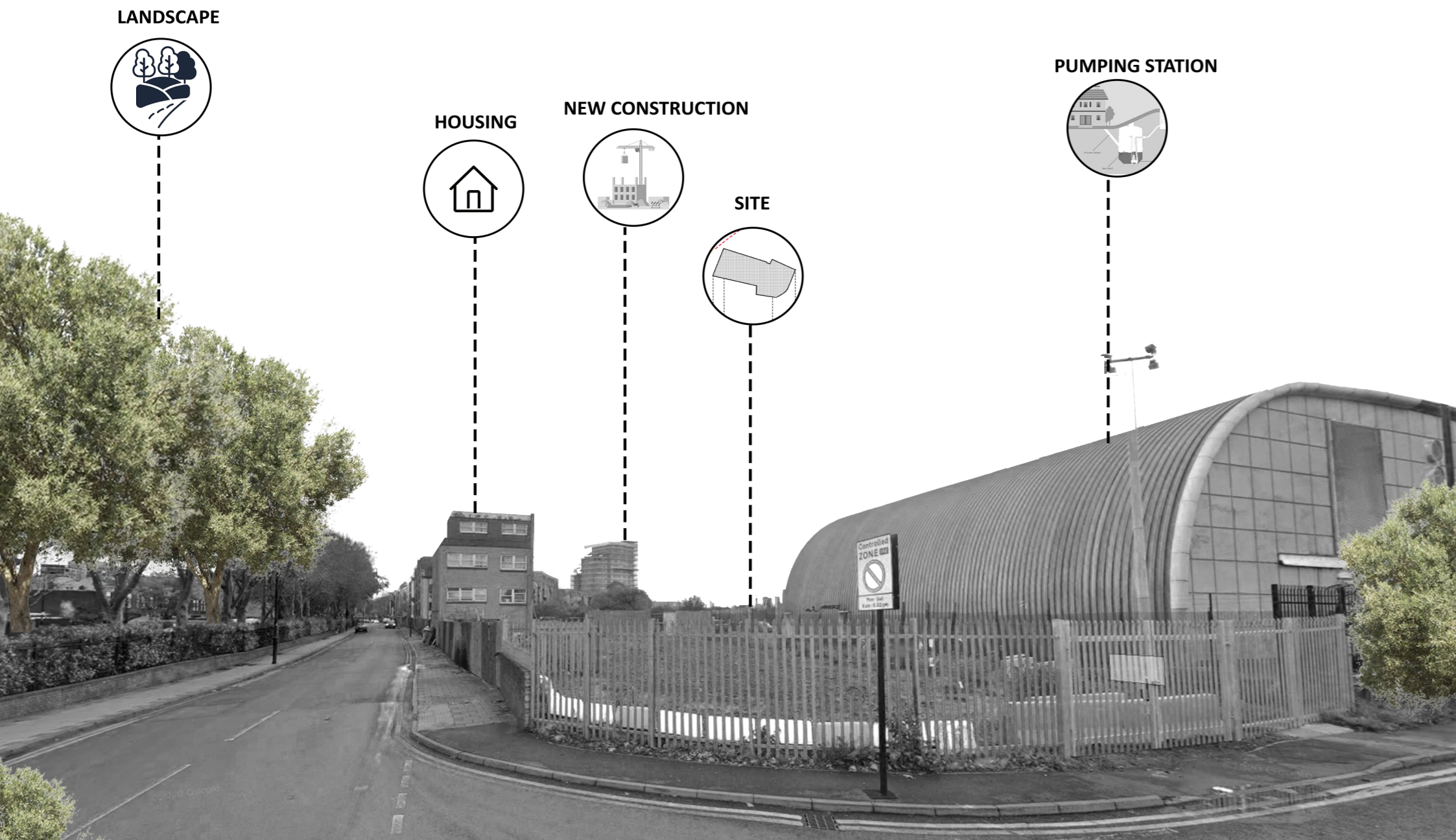

## 1.0 BRIEF

Our masterplan aims to create space where humans, flora, and fauna could thrive together. The site is divided into two parts: one for the container that will be placed there and the space for the cars to enter, manoeuvre and exit out of the site, and the other for a butterfly farm. It contains many points of interest including a pond with a river connecting to a staircase of planters where rainfall would fall down that staircase, it would be filtered by the vegetation, and it would then collect into the pond. There is also a bridge going across the river that connects the points of interest so that people do not require to circumvent it. Its walls would be covered in vegetation, there would be a web of footpaths passing by every space a visitor would be interested in, as well as seating and planters with vegetation sprawling from them. The choice of transforming part of the site into a butterfly farm was derived from the fact that butterflies could be found on-site when site analysis was conducted therefore the vegetation on site could be used as a template for what other types of vegetation could be added to the site. The organic shape of the bushes sparked an idea of mimicking this same shape for the seating installations. Instead of regular benches, the design of the seating would be more akin to something derived from nature itself as are the materials used to create it.



# 2.0 SITE ANALYSIS

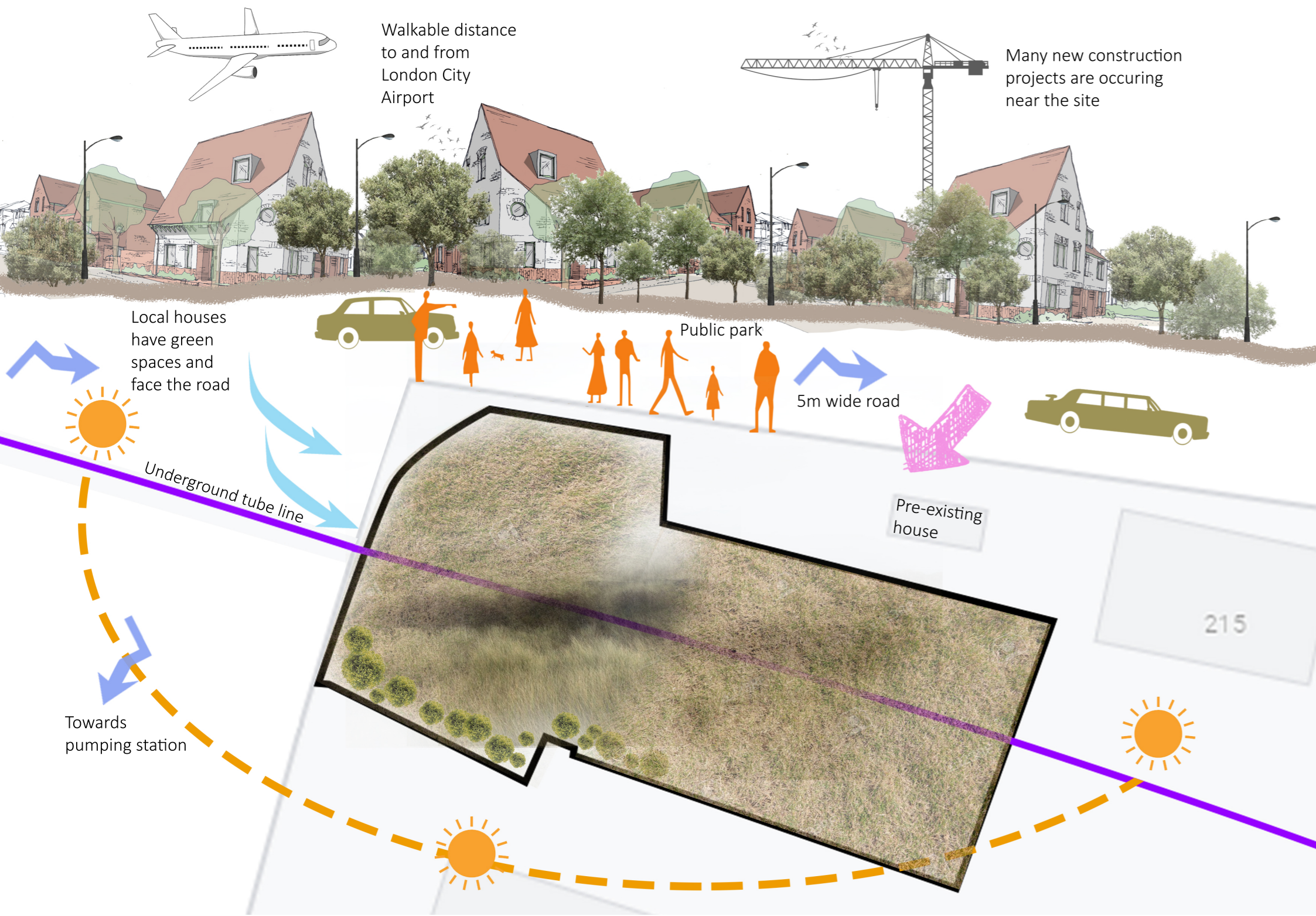
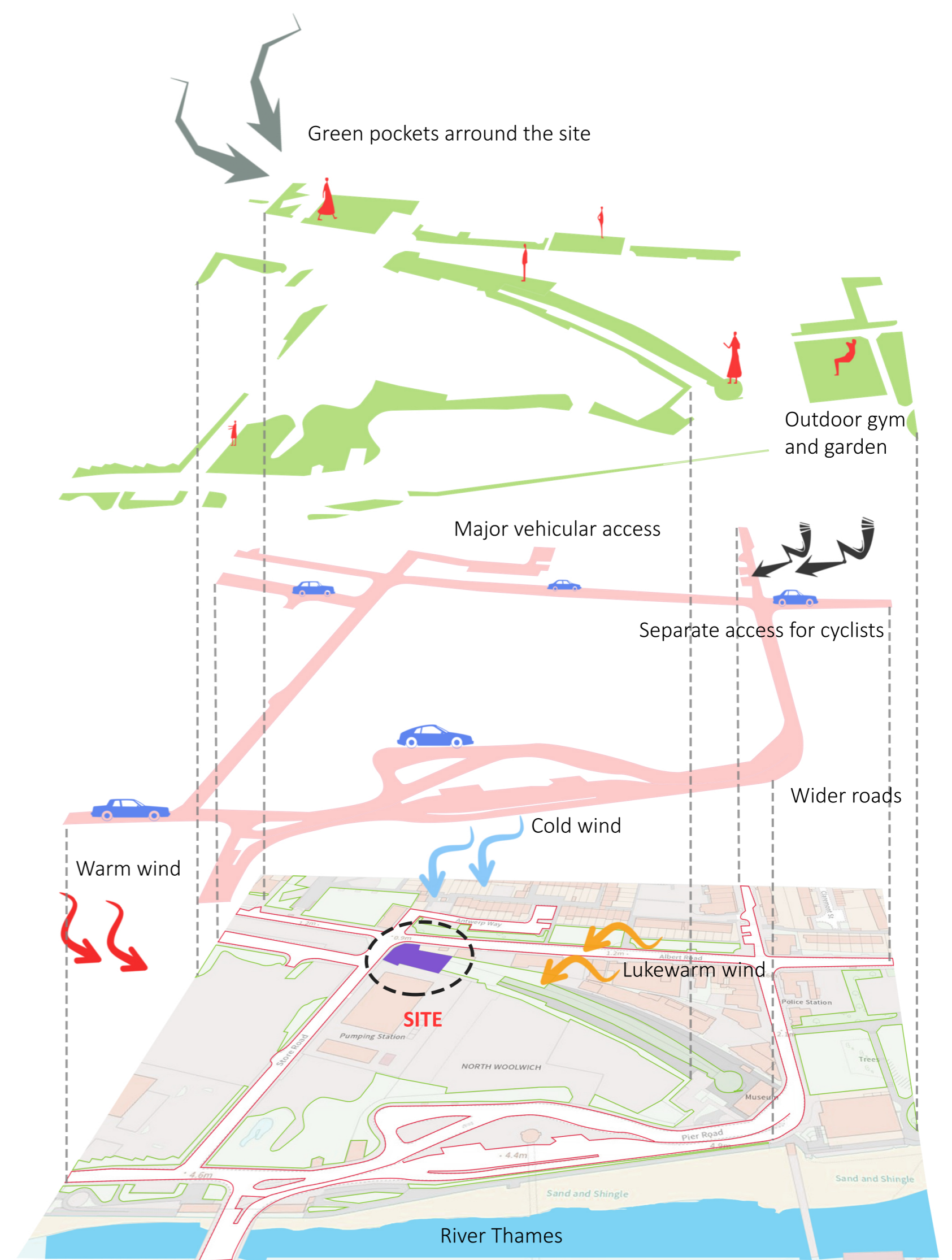

Fig.01 - SITE ANALYSIS





### 3.0 INITIAL DESIGN

#### 3.1 SITE VISIT

The first day of the project was focused on the interaction with the local council and the Newham Sixth-Form College students in collaboration with Tate and Lyle sugar company.



Fig.02 - INTRODUCING US TO THE WORKING SITE

#### 3.2 DESIGN INSPIRATION

The biodiversity, local environment, vegetation, and insects inspired us to attempt to transform the site into something that the local life would thrive in. The effect will cater not only to people, but also to the plants and varied species of insects, especially the butterfly species that were the most predominant in the site (Holly Blue, Peacock, Comma).



Fig.05 - A BUTTERFLY ON SOME GROWING VEGETATION



Fig.03 - ENTERING THE SITE OF OUR PROPOSAL



Fig.04 - ANALYSING THE SITE



Fig.06 - A CLOSE-UP OF ONE OF THE PLANTS



Fig.07 - A BUTTERFLY ON A DANDELION FLOWER



3.3 DESIGN IDEAS



Fig.08 - NEWVIC STUDENTS' IDEAS FOR THE SITE PROPOSAL (CLAY SEATING AND BIRDHOUSE MODELS)

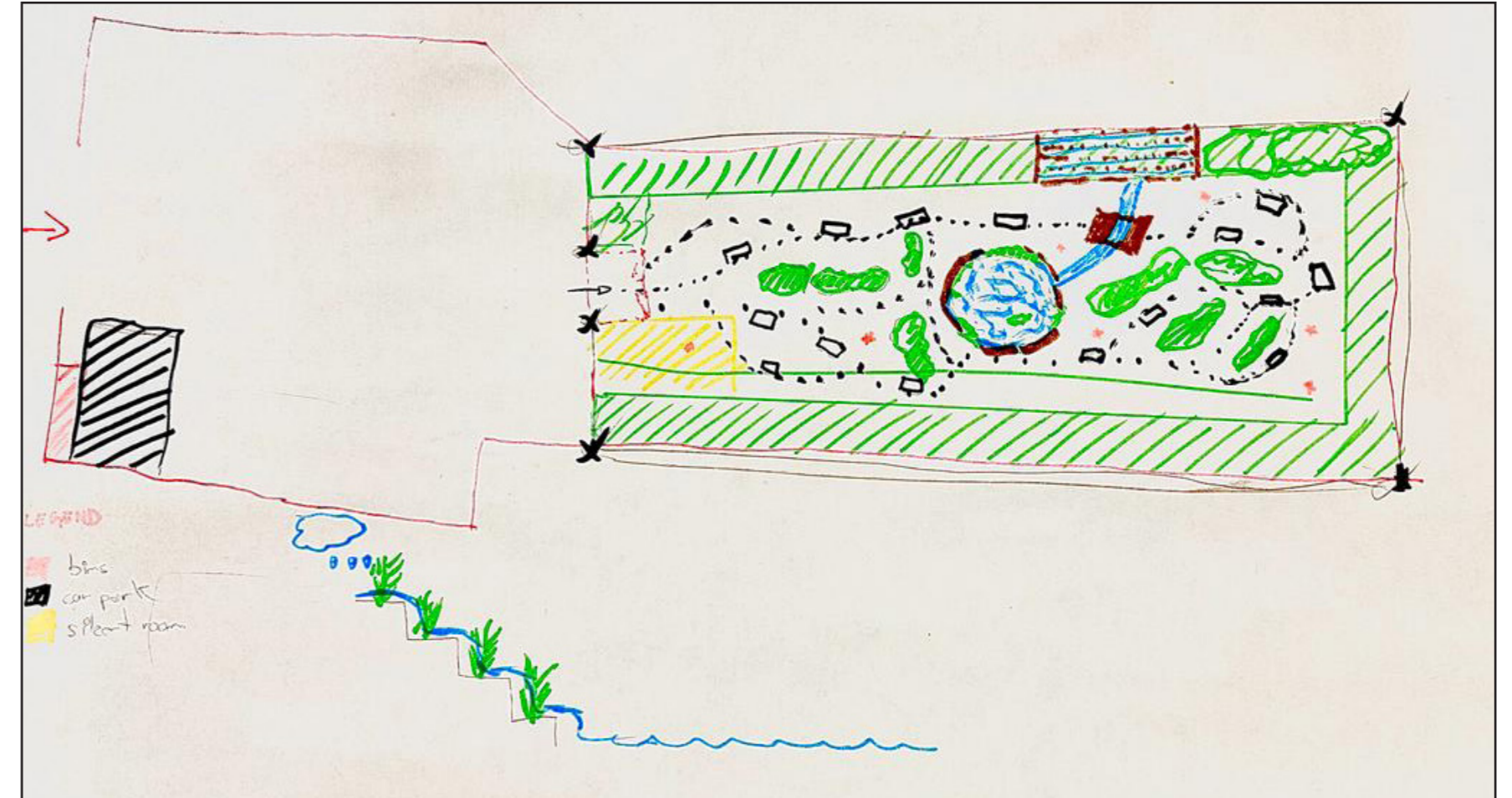
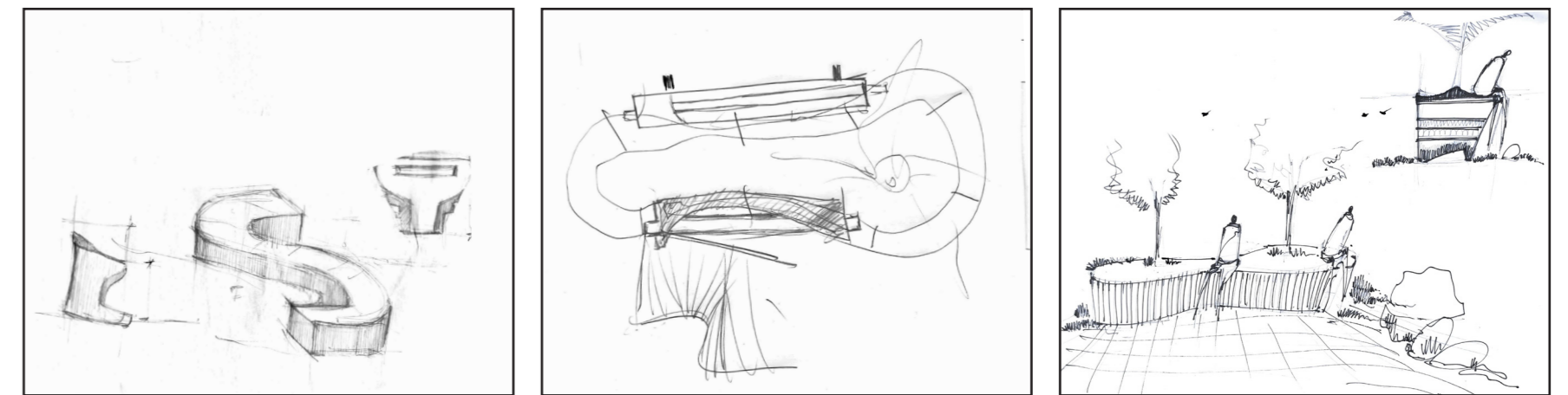

Fig.09 - INITIAL DESIGN SKETCHES







### 3.4 DESIGN DEVELOPMENT

Taking into consideration NewVIC students' desire to cultivate various plant species on the site, we proposed integrating their ideas into our bench design.

The main shape of our design was derived from the body of a butterfly by dividing it into two main parts: the main body and wings.

-Main body - representing for the life and ecosystem.

-Wings - colourful and attractive pattern.

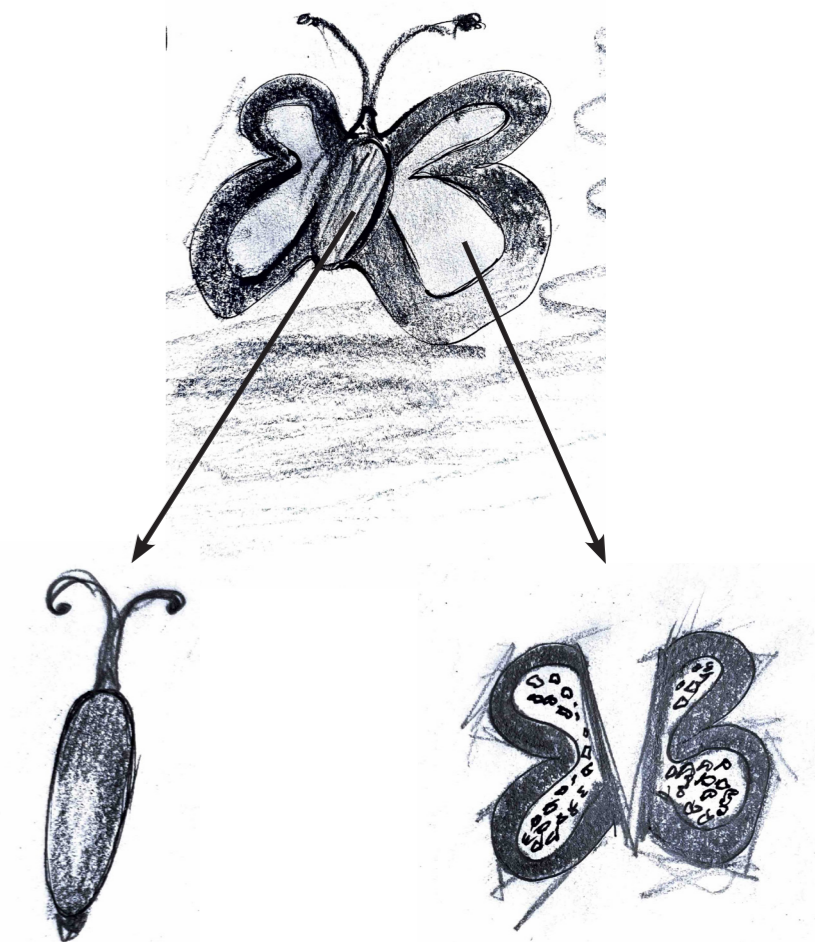

Fig.10 - HOW THE SHAPE WAS DERIVED FROM A BUTTERFLY



Once we had a design concept in mind, we started producing a 1:10 clay model to simulate the relative size and proportions of the bench.



Fig.11 - PROTOTYPE 1:10 SCALE



Taking into consideration that the bench would be exposed to the elements, we started considering a method to prevent a potential environmental impact such as erosion due to rainfall. To prevent that, we implemented a slope on top of the surface that would allow the water to trickle down and not collect on the top surface. The implementation of this slope minimises the absorption of the water by the Sugarcrete.

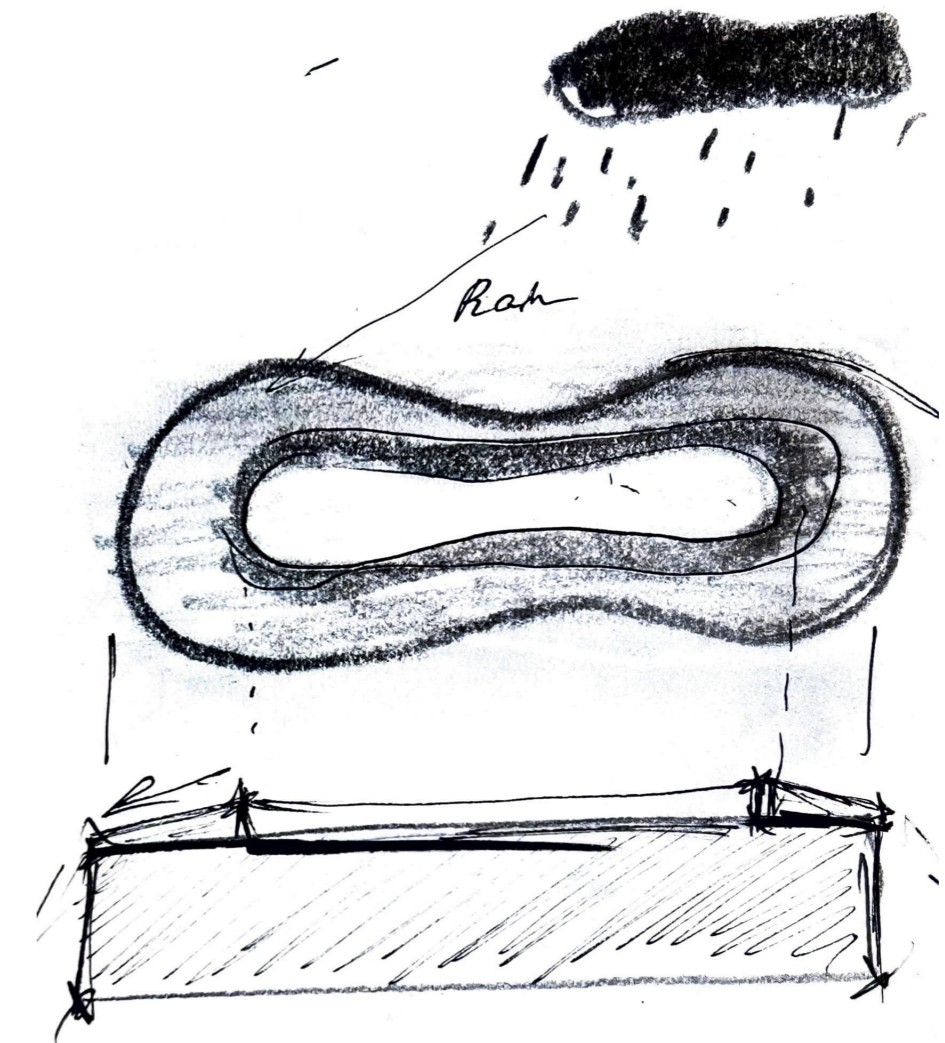

Fig.12 - A SKETCH DEPICTING THE SLOPE



The next step of the proposal was to divide the bench into 14 segments. Of these 14 segments, 3 shapes could be replicated 4 times, and 1 shape could be replicated twice, connecting the bench in the middle. The reason for dividing the bench into 14 pieces was to make the casting and transportation to the site more manageable.

**CONSTRUCTION MATERIALS :**

THE MODEL IS DIVIDED IN 14 PIECES, HAVING A 6.5m PERIMETER ON THE EXTERIOR SIDE OF THE BENCH. AND THE INTERIOR SIDE OF THE BENCH HAS A PERIMETER OF ≈ 4.5m

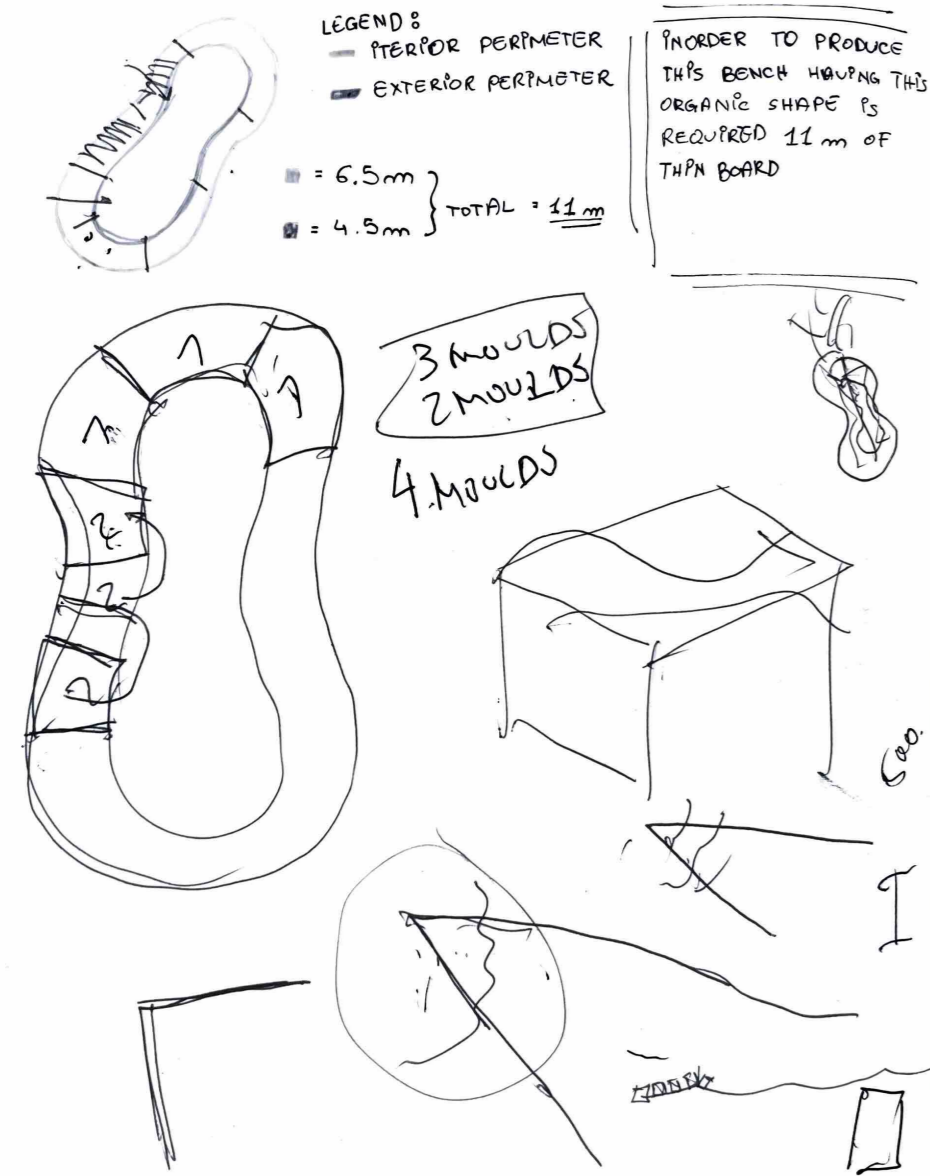

Fig.13 - INITIAL SKETCHES OF THE DIVISION

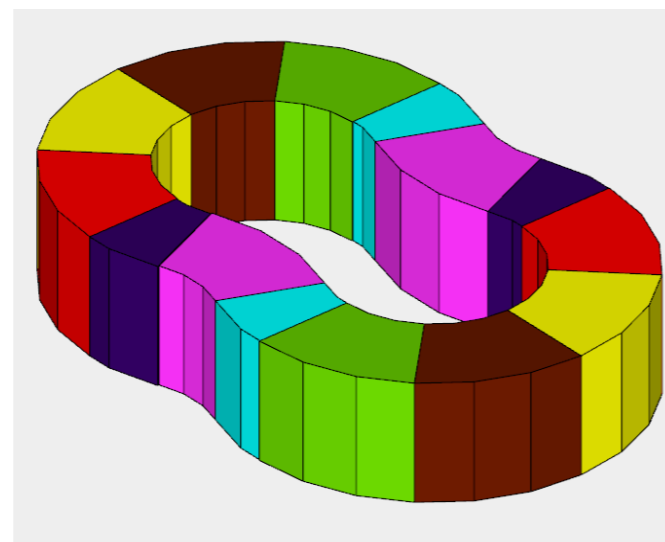
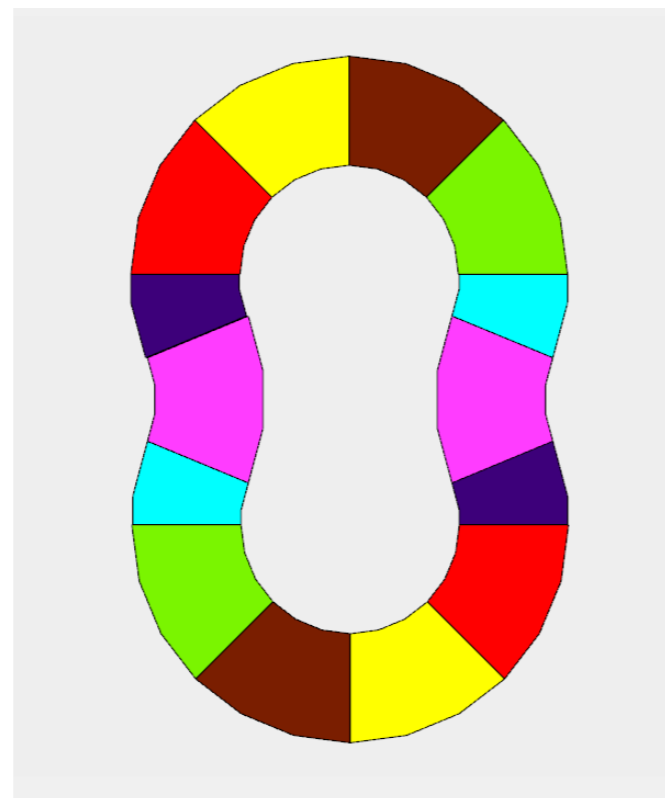

Fig.14 - INITIAL MODELS OF THE DIVISION

By dividing the bench into 14 pieces, we started to reflect on how the segments could be joined and secured to prevent any unwanted movement. The strategy that was introduced was to connect them via butterfly joints, so that it would fit the overall inspiration narrative. To create the slots for the joints, two halves would be placed on the interior side of the model, then removed when the Sugarcrete cures. Once the voids are made and all the pieces are created, the next step would be to insert the timber butterfly joints into their slots.

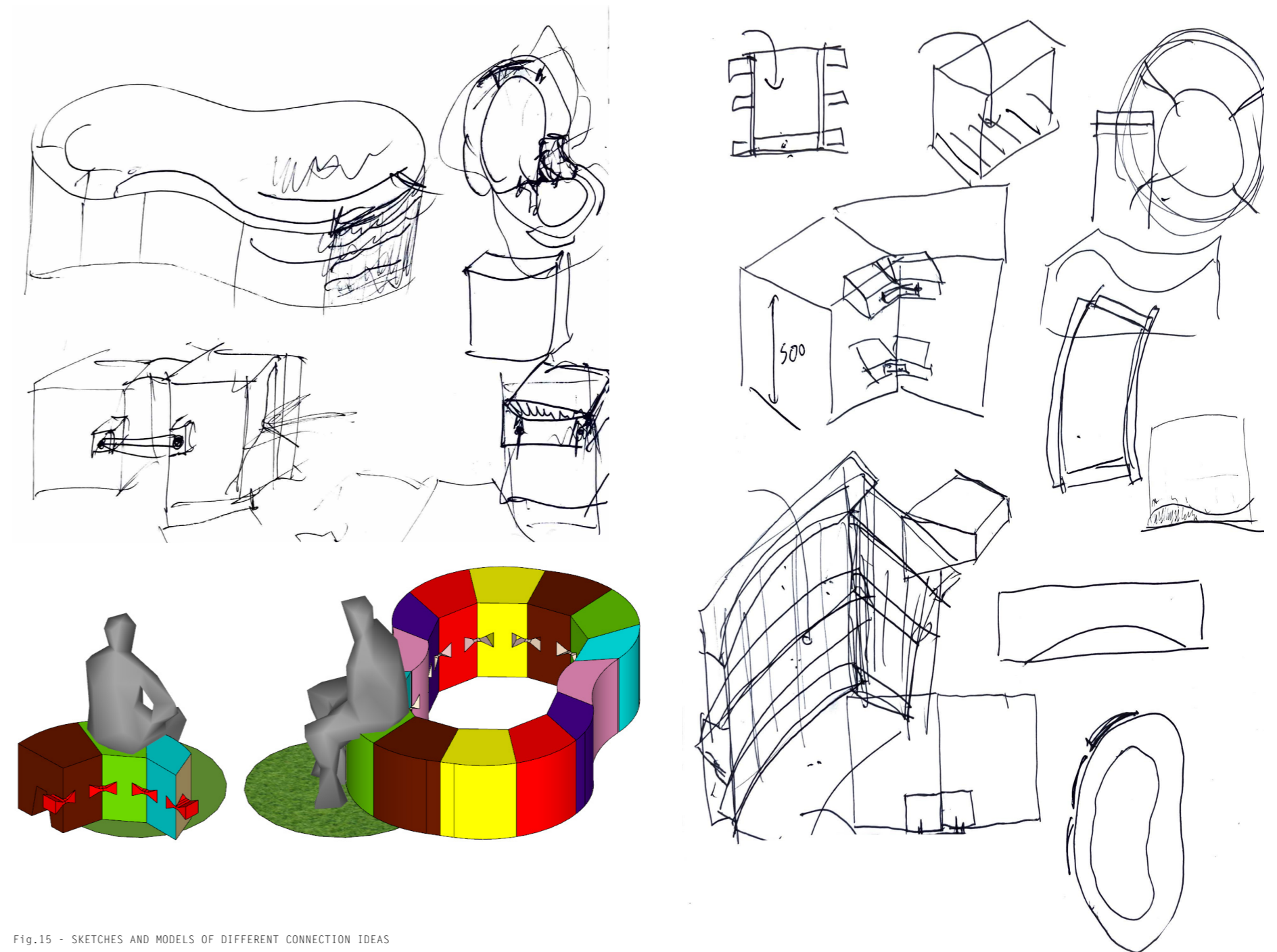

Fig.15 - SKETCHES AND MODELS OF DIFFERENT CONNECTION IDEAS



A strategy that was introduced to reduce the weight of the cast involved the creation of a void on the bottom of the cast. To achieve that, a foam negative would be placed inside the mould, then the Sugarcrete mixture would be poured all over and around the foam block, enveloping it, but not engulfing it, making it possible for the piece to be retrieved and reused.

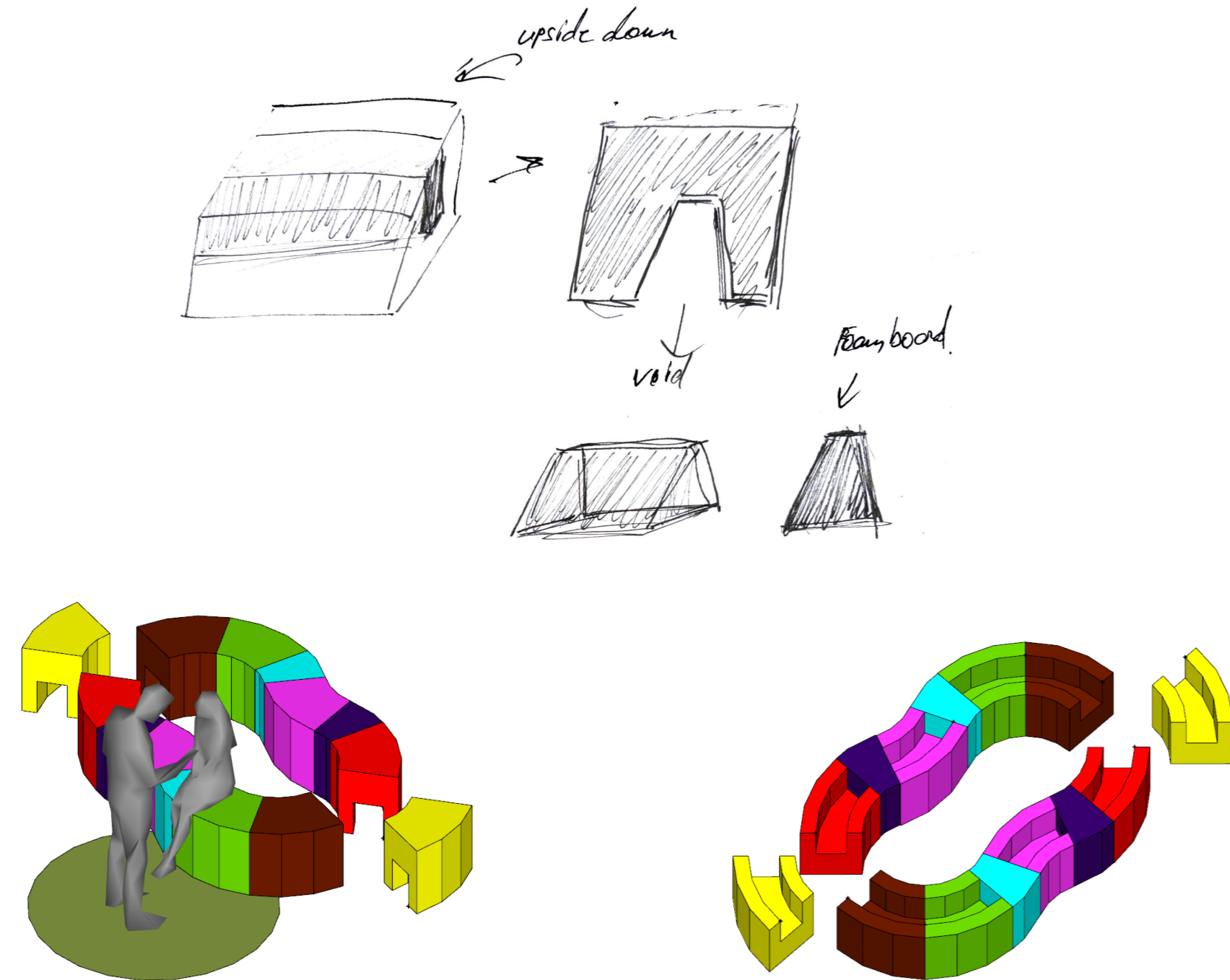

Fig.16 - SKETCHES AND MODELS OF THE VOID

To create a separation gap between the top surfaces of some of the segments and the timber seating that would be installed on top, two pieces of timber would be cast into the top of the Sugarcrete piece, perpendicular to the positioning of the timber seating, so that they raise the timber seating above the Sugarcrete, but also creating points to which the timber seating plank can be screwed. The reason for the need for the seating to be slightly raised is to prevent any blockage in the slope on the top and so that the people sitting would not risk their clothing absorbing the leftover moisture.

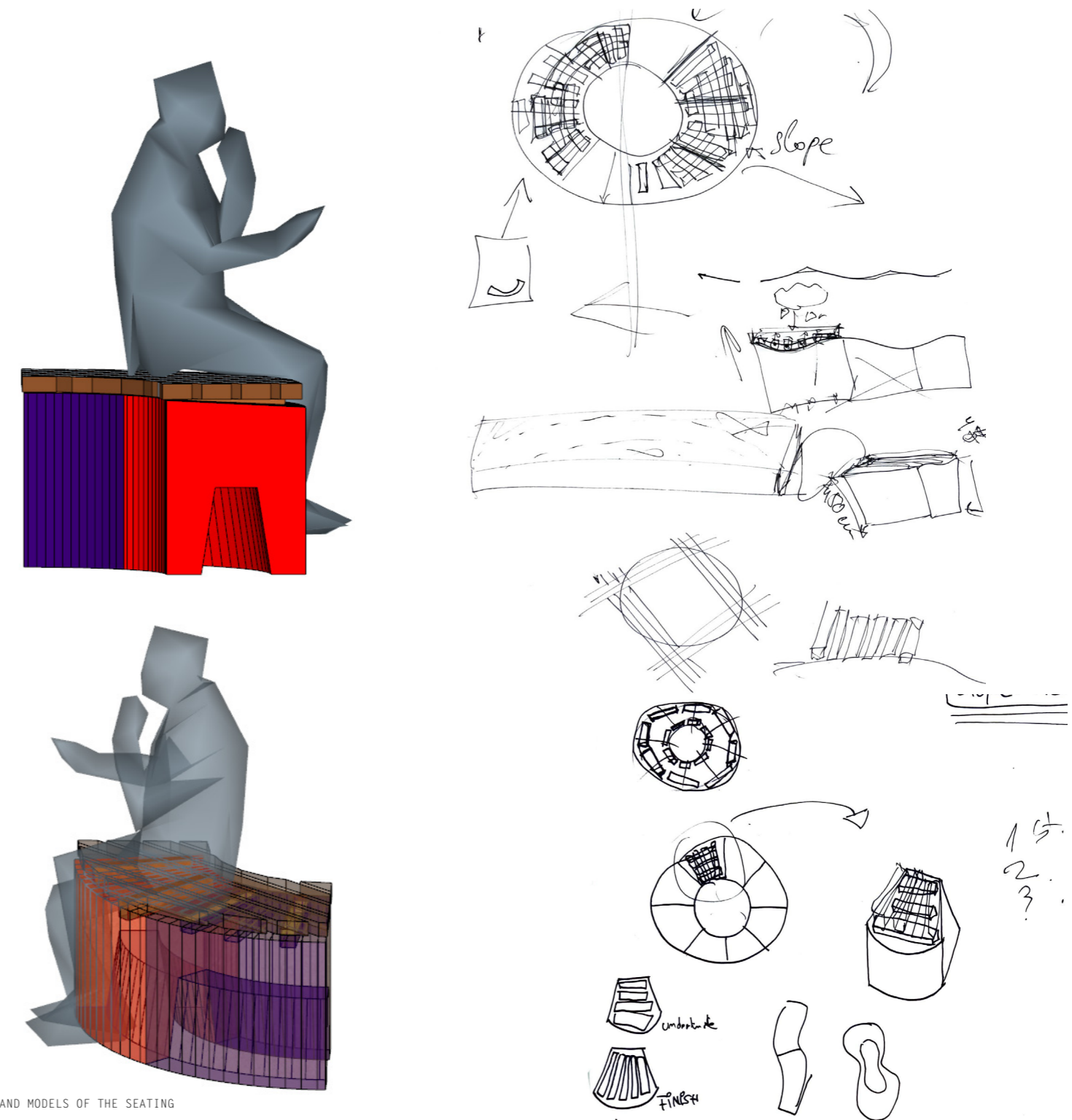

Fig.17 - SKETCHES AND MODELS OF THE SEATING



Initially, to create the slope on top, the plan was to cast each segment upside down.

The negative of the slope would be built up by using sand or earth which would then be compressed. The result of this process would create a smooth top surface and the desired slope.

By experimenting with this type of process we decided not to add timber planks on every cast segment because the slopes would not be visible as they would be covered by the seating. Therefore, the top areas that are not dedicated for sitting will have a slope in more of an organic wave shape to add a simple aesthetic view to the overall design.

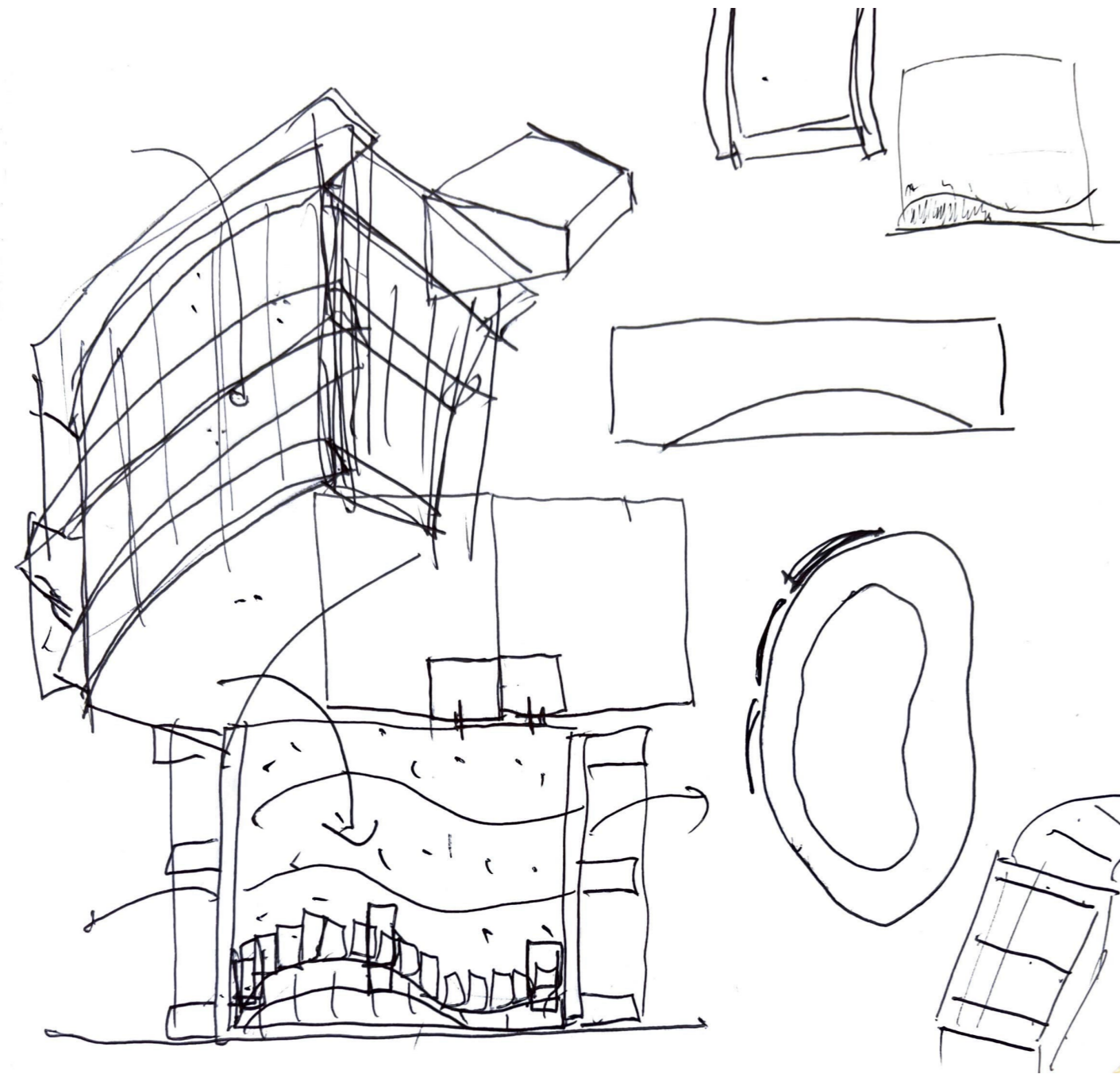

Fig.18 - SKETCHES OF HOW THE CURVE AND SLOPE WOULD BE FORMED

## 4.0 MISCONCEPTIONS

Before starting to realise this concept, we were able to note some impediments.

The first issue that came to our attention was that the way the piece was divided, it did not allow for versatile designs to be derived from the main form, moreover, the segments were too large for the casting and moving process to occur in a controlled manner.

Next, we came to the conclusion that the timber butterfly joints would cause too much of a structural compromise in the cast. Because the casts would be massive, the plan was to reduce the material and time consumption, as well as the weight, by introducing a void channel that goes through almost every piece. The problem with that was that this would either not make enough of a difference to be worth incorporating, or it would also compromise the structural stability of the segments.



## 5.0 FINAL DESIGN

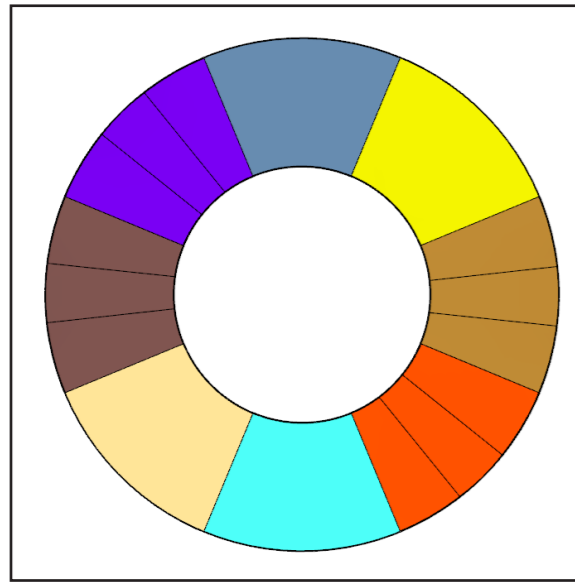

Fig.19 - TOP VIEW OF THE MODEL

After we analysed all the misconceptions that were present, we came up with various solutions for each. In terms of shape, the design was transformed into a circular bench that is divided into 8 equal segments. Having 8 equal segments that make up a circle would also increase the versatility and modularity of the design, allowing for various shapes and configurations to be formed. The way we conceived the circular shape is by dividing the previous design into equal parts. Then' due to the time constraints, we calculated that we would only be able to cast half of it, which led to a circular shape instead. This circle would be further calculated with utmost precision so that everything would line up as best as it could. The weight of each segment was now a much more manageable weight and the piece itself would be filled relatively easily.

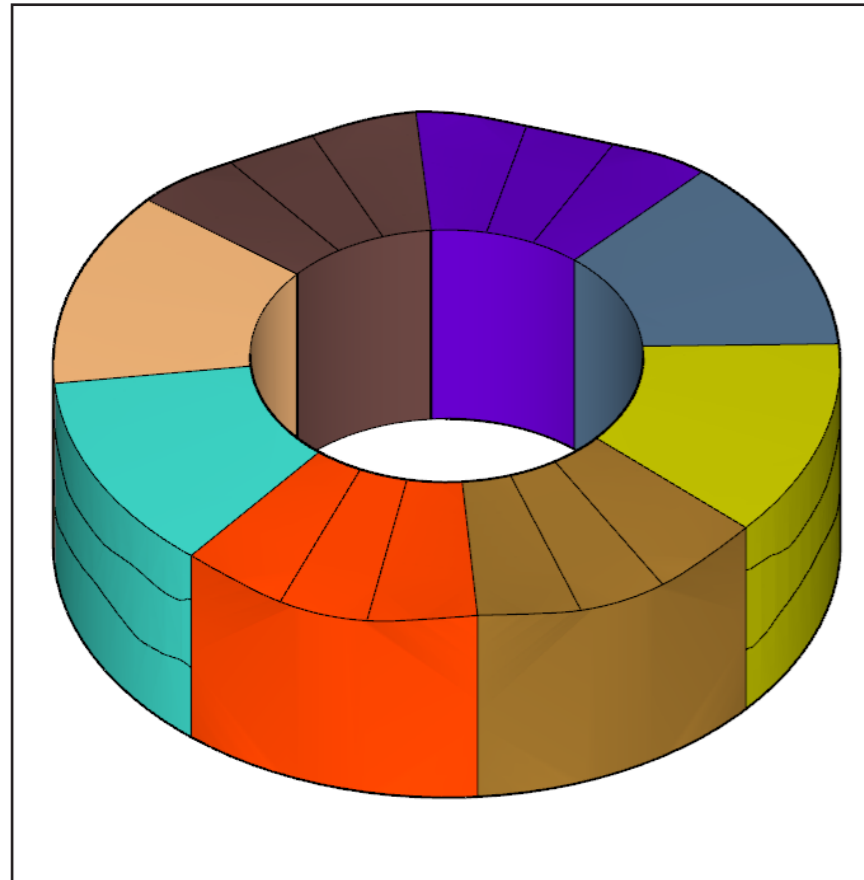

Fig.20 - AN AXONOMETRIC VIEW OF THE MODEL

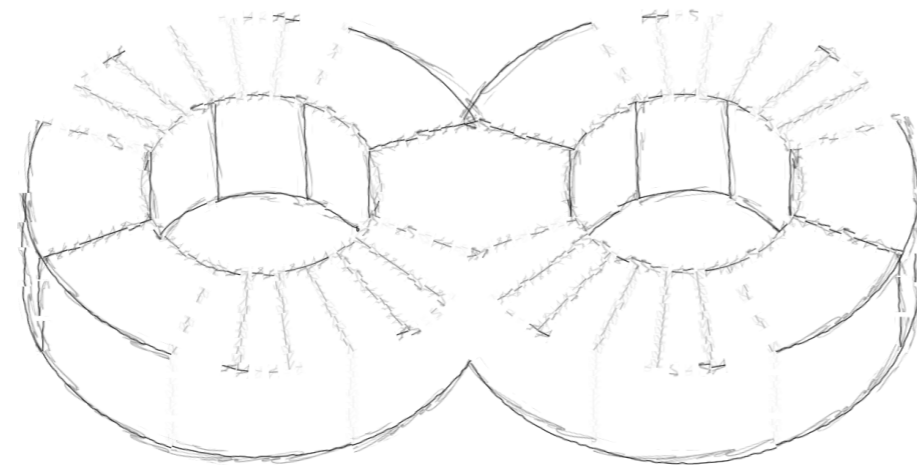

Fig.21 - A SKETCH OF THE UPDATED DESIGN

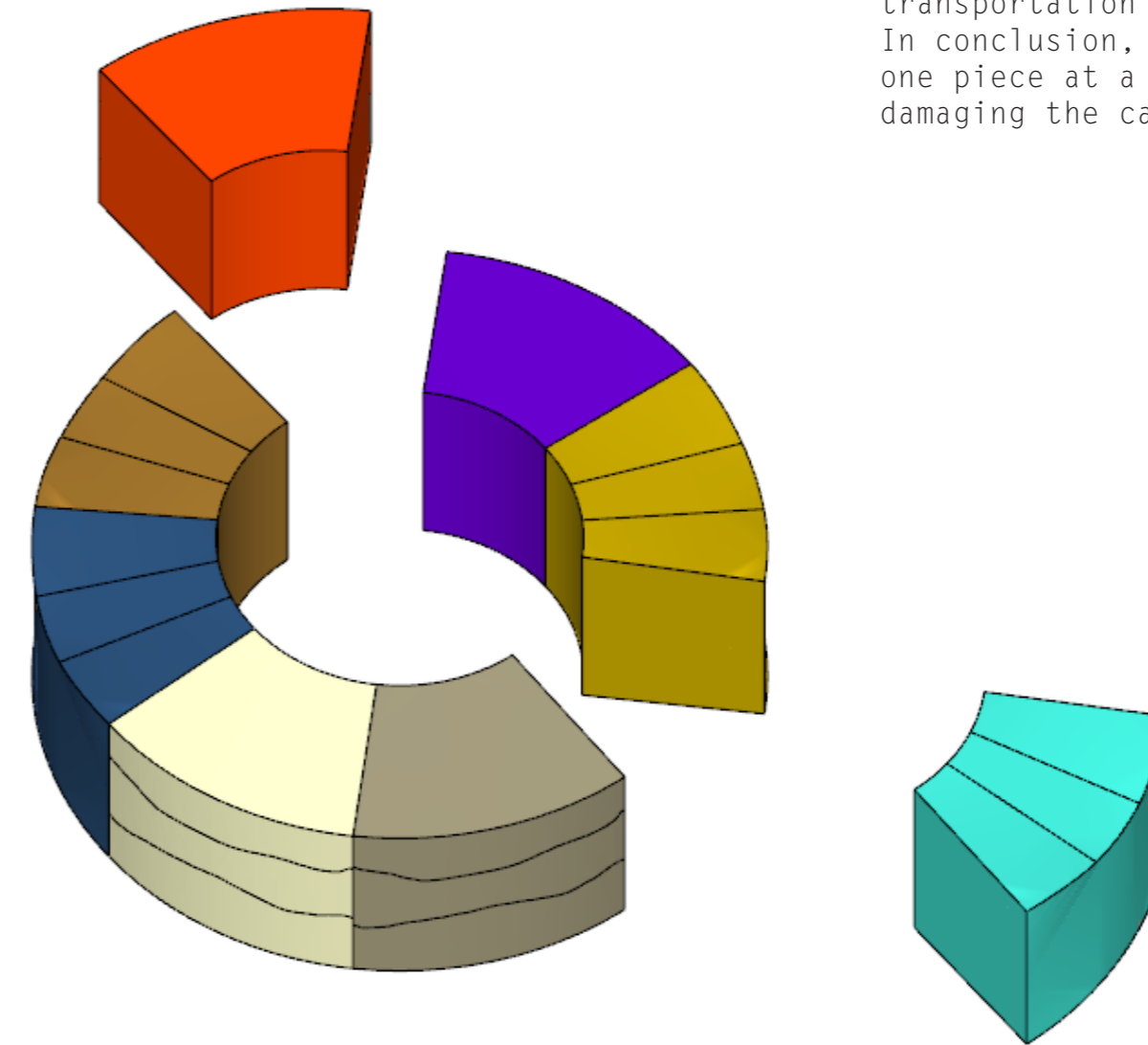

Fig.22 - AN EXPLODED AXONOMETRIC VIEW OF THE MODEL

By dividing the circle into 8 equal pieces, the weight of the whole bench is divided into more manageable pieces for easier transfer, which we later realised was crucial to our casting process as we would often need to move the pieces around the site for various reasons. Because the segments would need to be transported to the site where they will be installed, the fact that we have reduced their weight and size so much that they can be lifted by two people, makes the process of transportation much more manageable. In conclusion, if two people were to lift one piece at a time to move it, the risk of damaging the cast is reduced significantly.



Taking into consideration that all the segments are of the same shape and weight, we designed a piece to introduce a void inside the segments using foam boards so it reduces the weight of the cast. Unlike the previous design of the void, this piece would be enveloped from all four sides, making the overall structure more sound and less prone to damage. The process of creating this void begins by inserting a trapezoid prism made out of foam board, before we begin casting. After the cast cures, the foam shape can be retrieved and subsequently reused for other moulds.

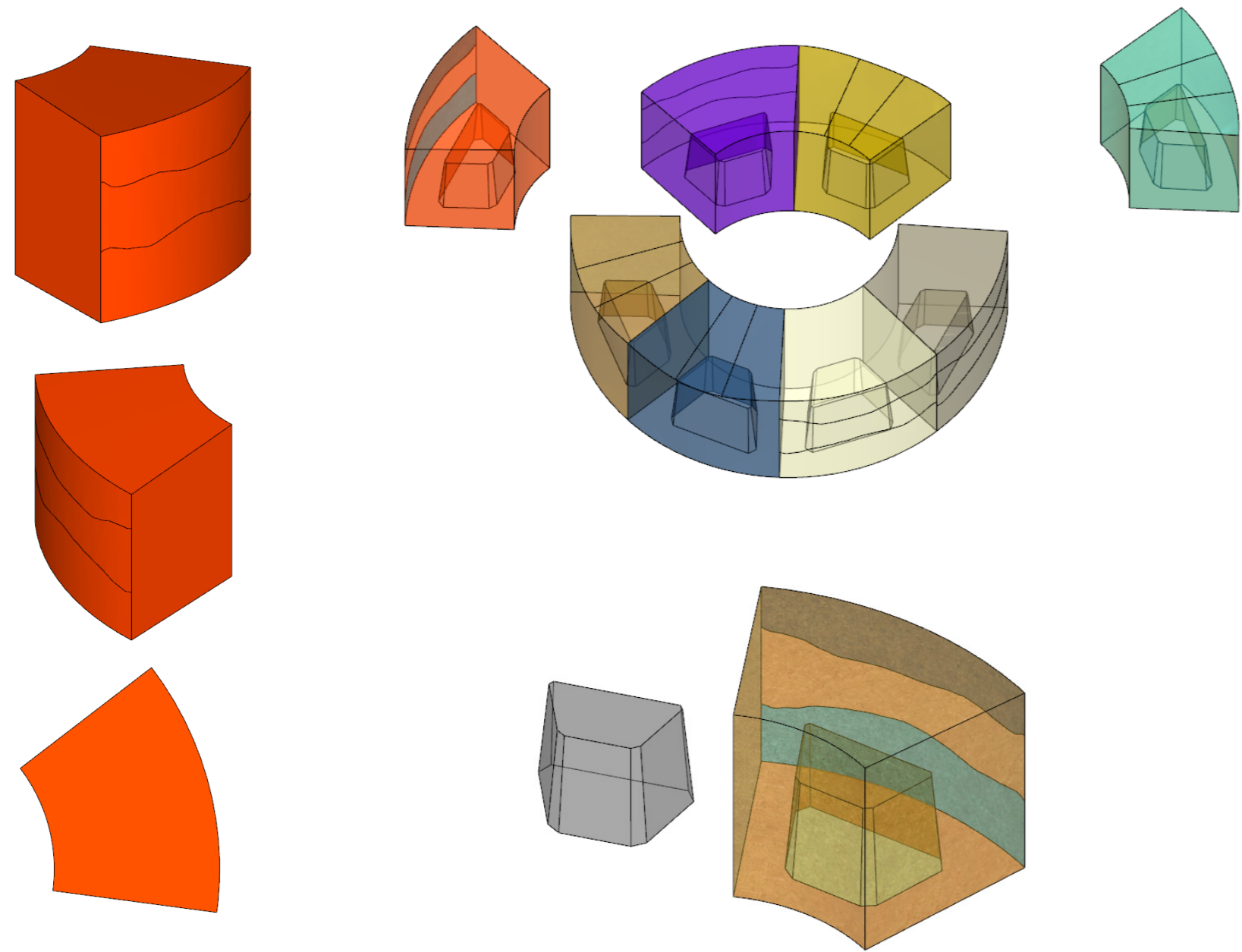
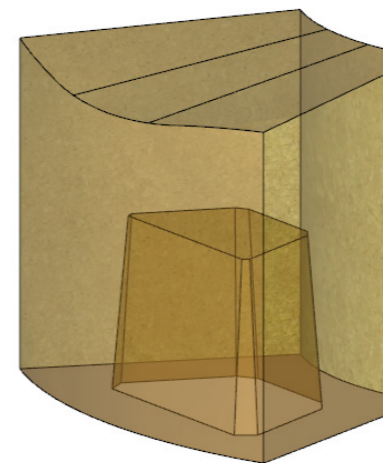
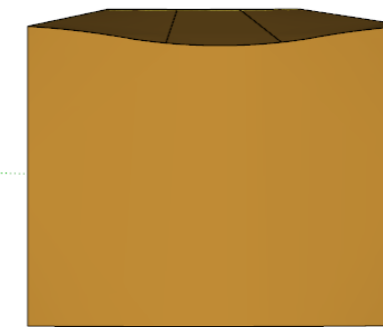
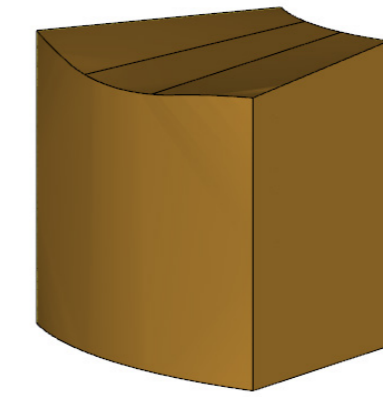

Fig.23 - DIFFERENT VIEWS OF THE SEGMENTS AND THE VOID INSIDE THEM



Taking into consideration the short timespan that we had to complete the project, we created a tool which would function as a guide to replicate the same smooth slope that was implemented in the previous iteration of the design.

Additionally, for the wave-shaped slope for the pieces without timber planks for the seating, we made use of the same tool and for more freedom we used our hands to achieve the desired result.

One thing to note is that the top surface can be manipulated into the desired form once the cast has been left to dry for an hour or two.

Fig.24 - DIFFERENT VIEWS OF THE SEGMENT AND THE WAVE-SHAPED SLOPED TOP



## 6.0 MEASUREMENTS

When it comes to connecting the segments, the timber planks that attach to some of the pieces also serve as an added connection between them.

The main connection between each segment pair of trapezoid prism blocks made out of timber that are cast inside the segments. They are situated on the back side of the pieces. For an unintrusive joint, we placed one block on the top left side and one on the bottom right side, on half of the pieces. To make the connections happen, the other half of cast segments would have these positions mirrored. When arranging the pieces, the positions of the blocks would alternate so that two

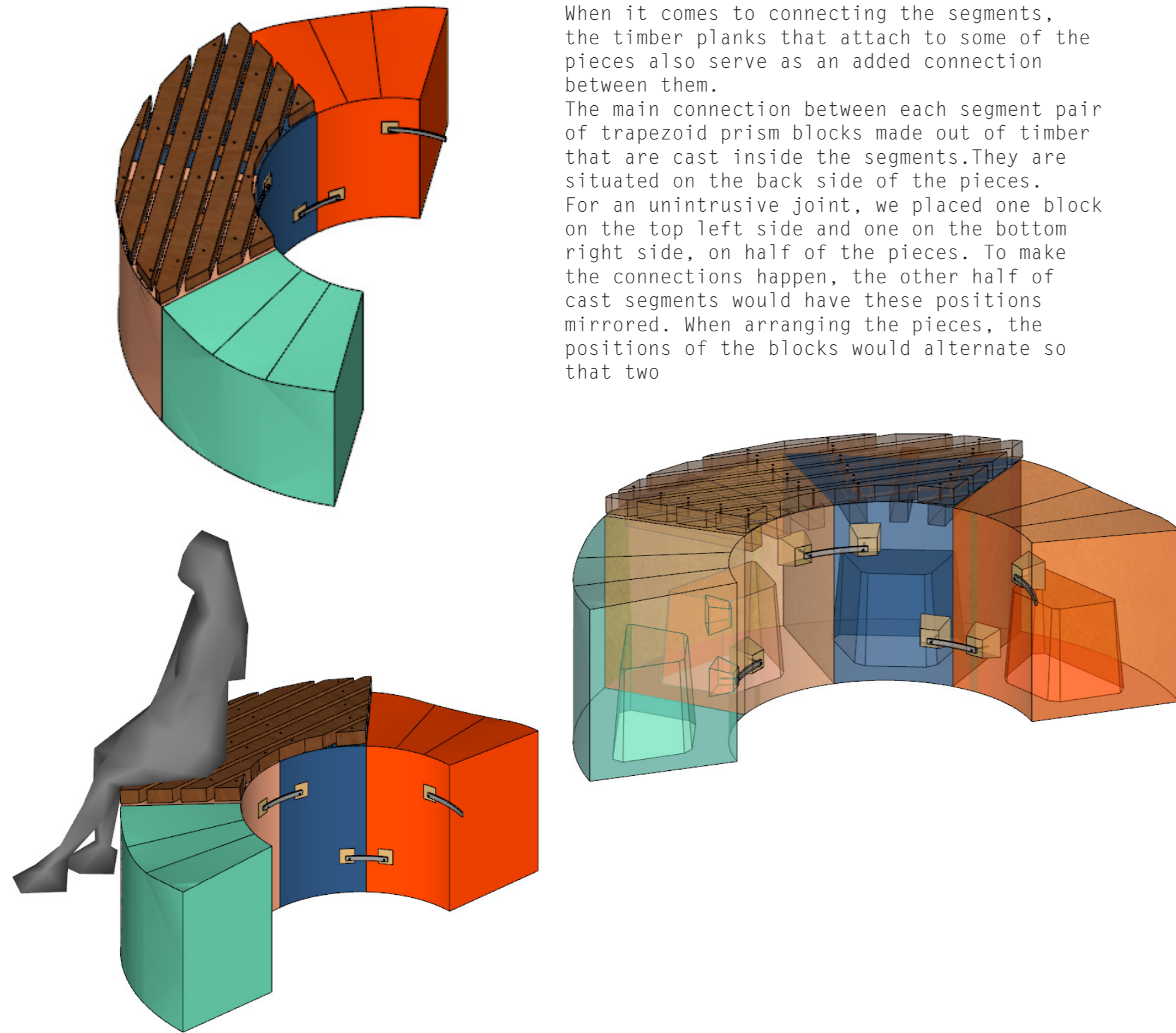

Fig.25 - SHOWCASING THE CONNECTIONS

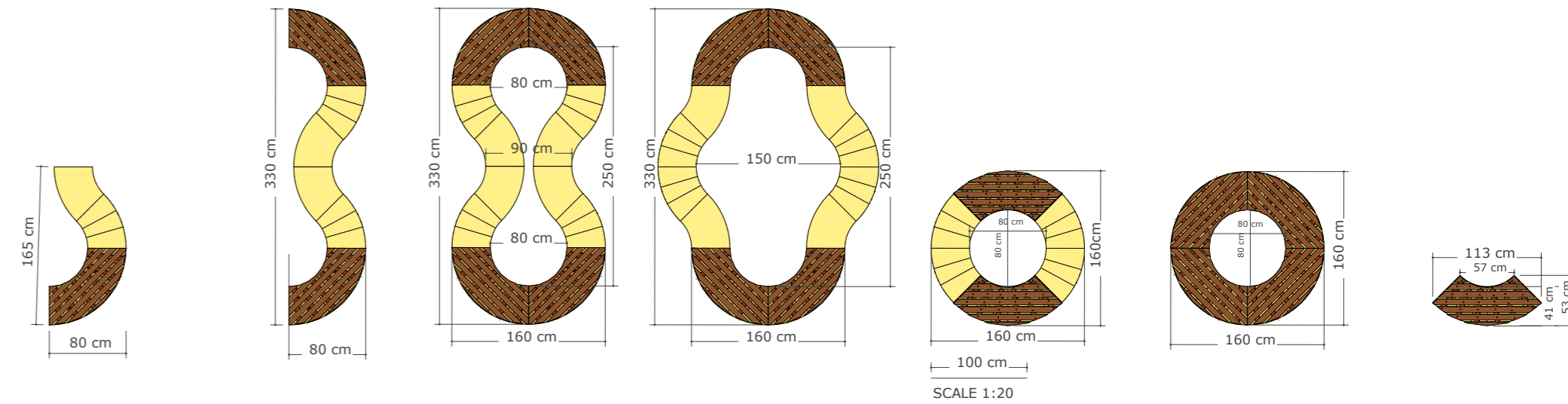

Fig.26 - DIFFERENT CONFIGURATIONS AND THEIR MEASUREMENTS



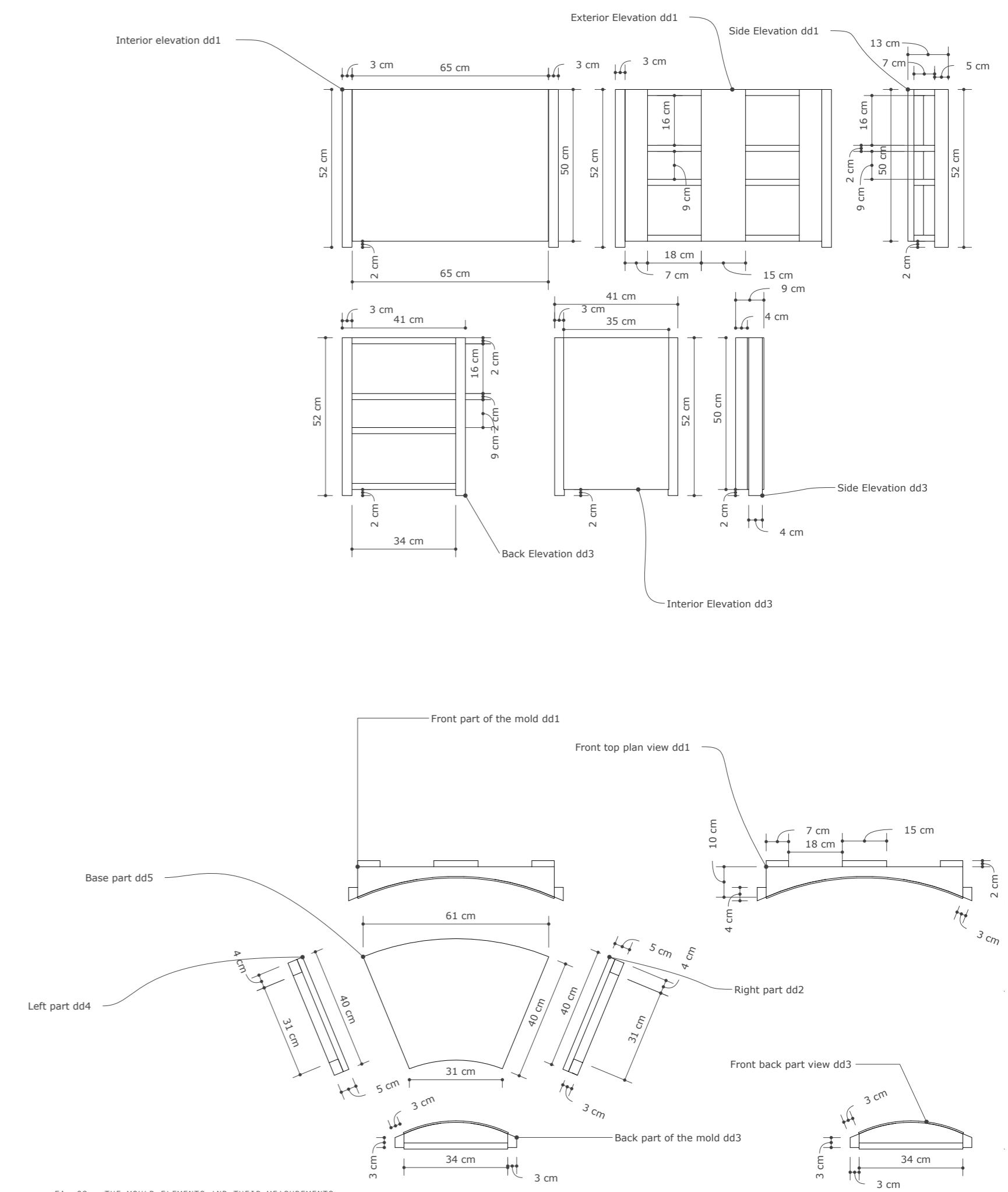
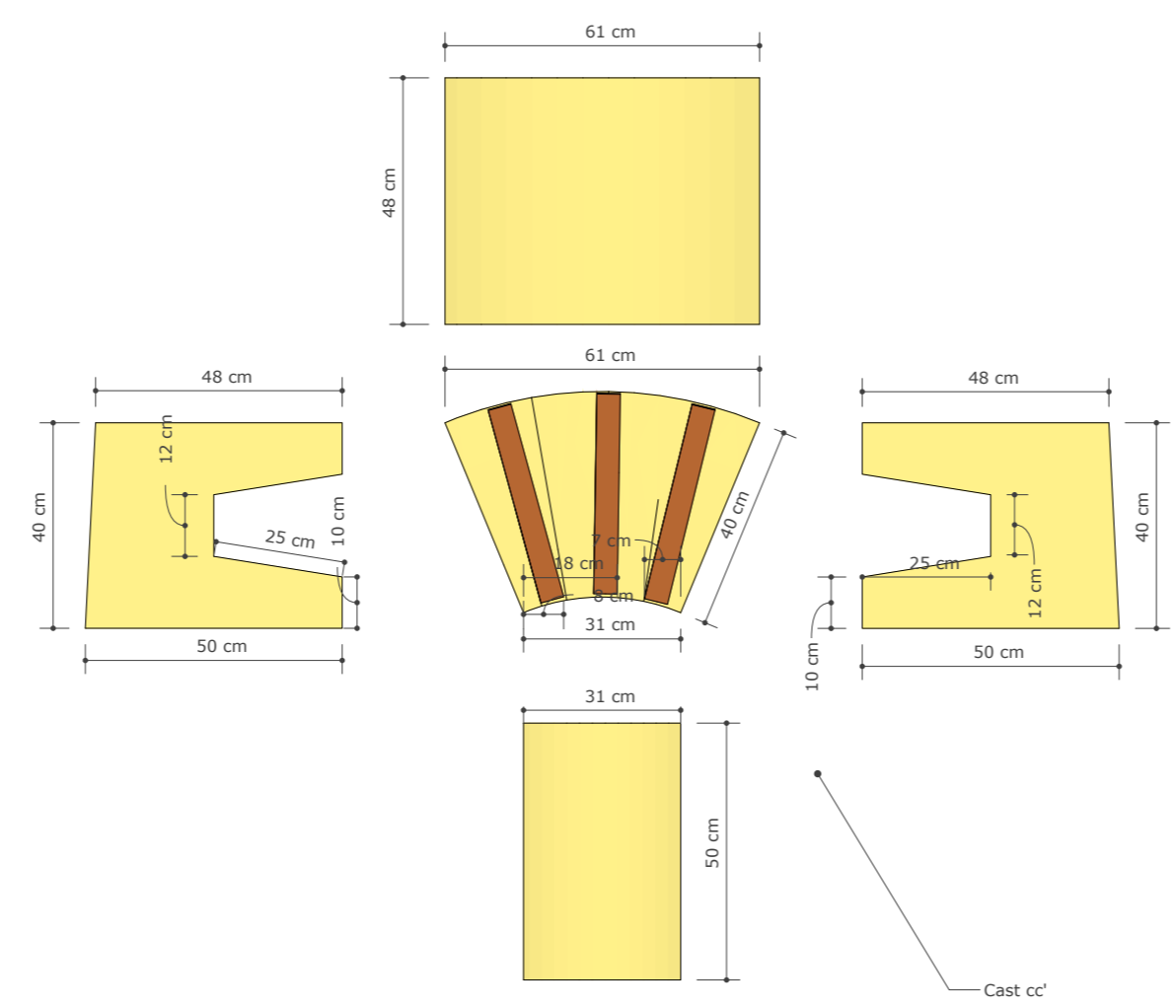
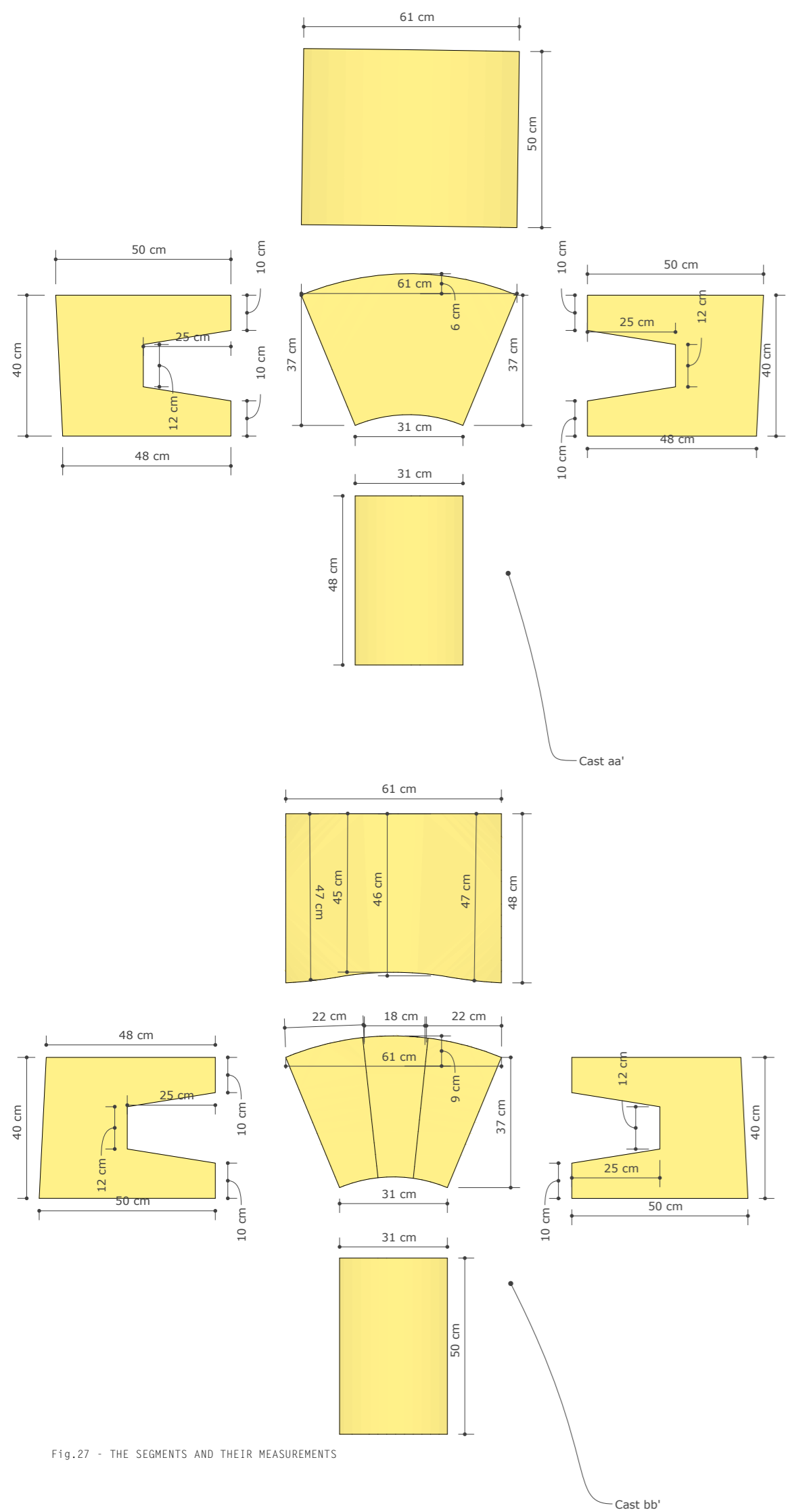

Fig.27 - THE SEGMENTS AND THEIR MEASUREMENTS

Fig.28 - THE MOULD ELEMENTS AND THEIR MEASUREMENTS











# 7.0 MOULD CONSTRUCTION

## 7.1 MATERIALS



Fig. 29 - HARDWOOD TIMBER



Fig. 30 - PLYWOOD TIMBER



Fig. 31 - MDF BOARDS



Fig. 32 - THIN PLYWOOD SHEETS

## 7.2 TOOLS

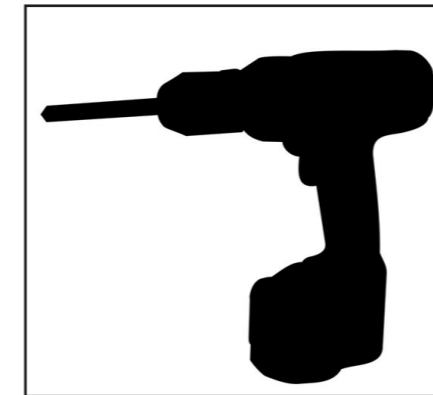

Fig. 33 - DRILL x2

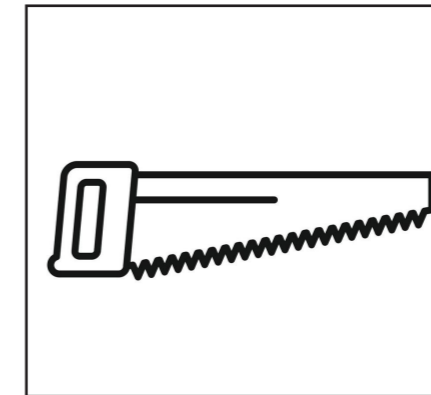

Fig. 34 - HAND SAW x1

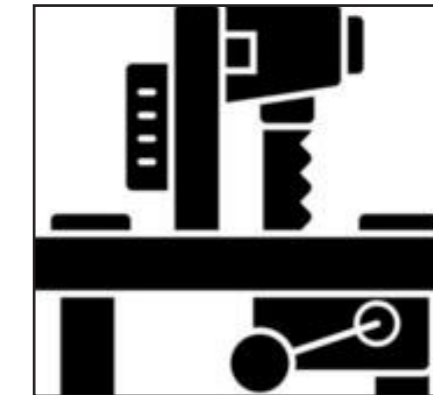

Fig. 35 - BAND SAW x2

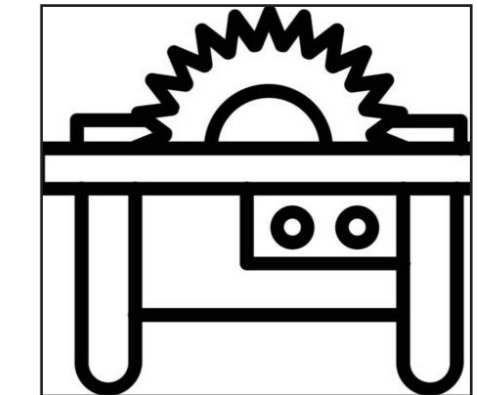

Fig. 36 - TABLE SAW x1

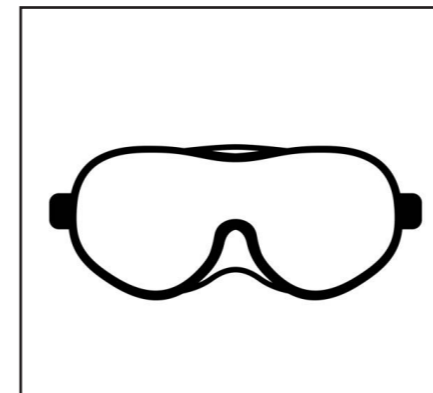

Fig. 37 - PROTECTIVE GOGGLES x4

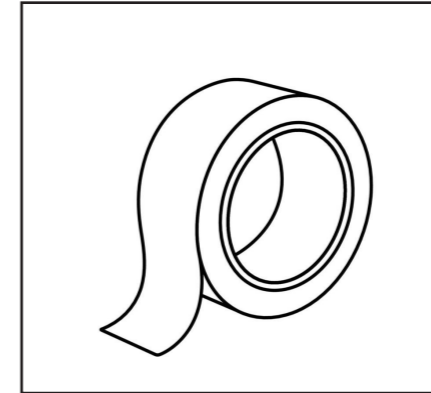

Fig. 38 - PLASTIC TAPE x4

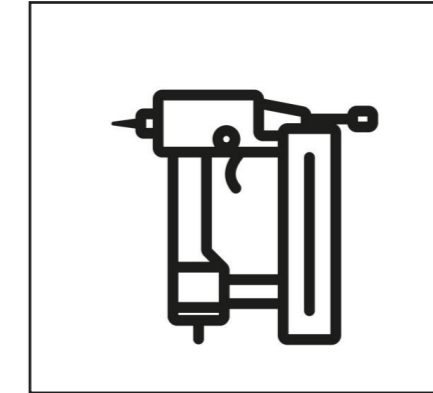

Fig. 39 - PNEUMATIC STAPLER x1



Fig. 40 - FACE MASK x4

## SCREWS

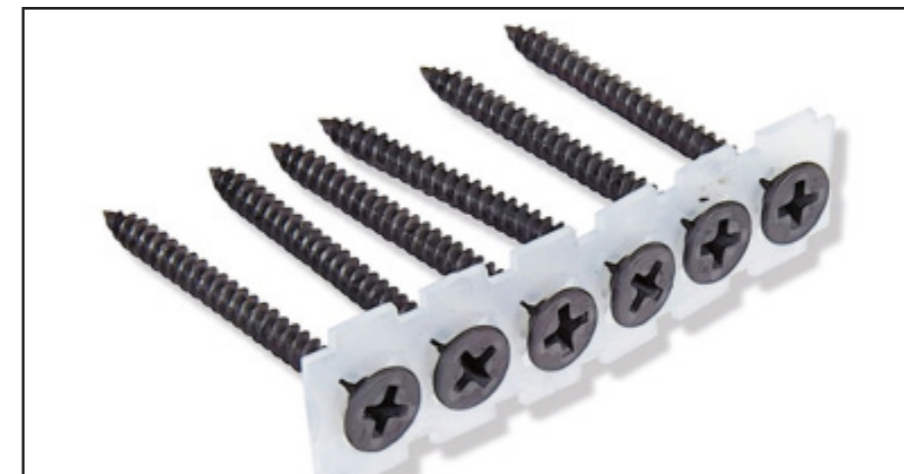

Fig. 41 - BLACK SCREWS 30MM x59(PER MOULD)

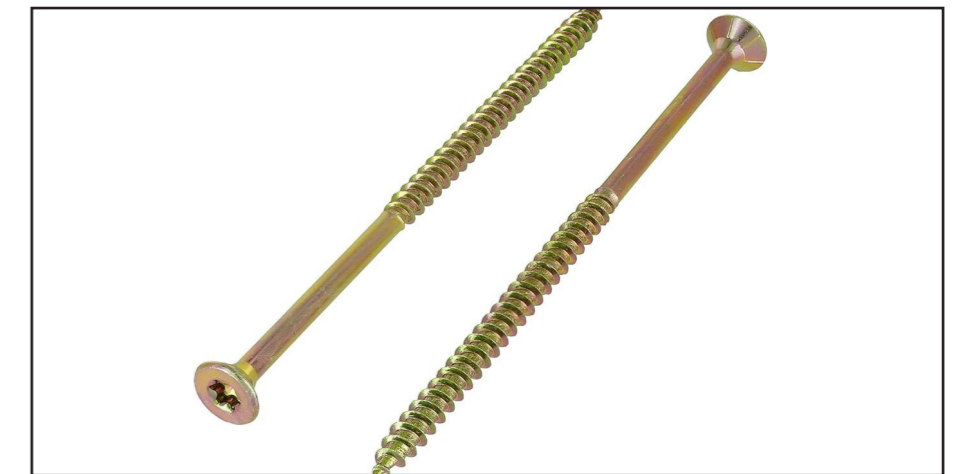

Fig. 42 - WOOD SCREWS 100MM X12 (PER MOULD)





Fig. 43 - PAPER TEMPLATE BENCH SIMULATION

7.3 MAKING THE BASE

The first objective for this stage was to print the shape of the inner side of the mould, which would be the footprint of the cast. To confirm that the measurements were correct, we printed copies of the template in total so that we could tape them together to see if they would form a circle. (Fig. 43) After confirming the measurements were indeed accurate, we used one of the templates to trace its perimeter on a rectangular piece of hardwood timber so that we could cut the base using a bandsaw available in the workshop. We made sure to leave the necessary spaces for the pieces which would be resting on the base. (Fig. 44) The same process was implemented to produce a top reference but it was cut alongside all of the template lines so it can fit at the top of the mould. (Fig. 45)



Fig. 44 - BASE



Fig.45 - TOP REFERENCE



Fig. 46 - CUTTING THE WALLS

7.4 CUTTING THE WALLS

After obtaining a solid base for our mould, the next step was to cut two rectangular pieces of plywood which would be the walls that represent the beginning and end of the segment. In order to do so, we set up the height and width of the walls and then cut the excess material out, leaving us with a piece with the right dimensions. (Fig. 46) Once the dimensions of the walls were achieved, we positioned them on the base, making sure they aligned with the paper template. (Fig. 47) The final step of this part was to screw both walls into the base making while the paper template was still in the same position in order to achieve the right form for the walls. (Fig. 48)



Fig. 47 - SIMULATING THE POSITION OF THE WALLS

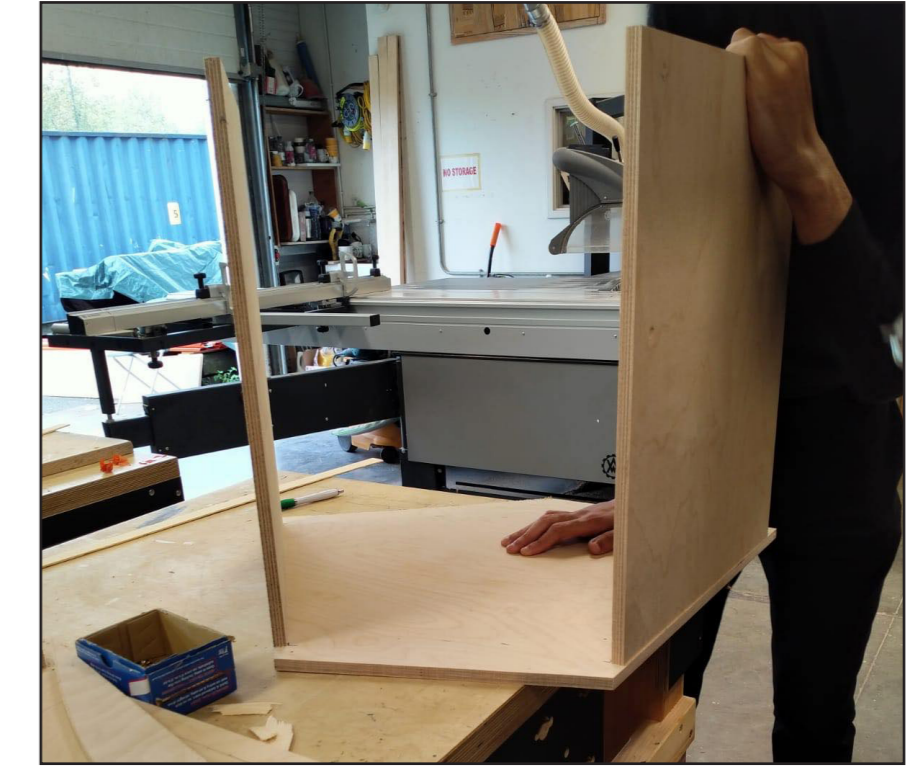

Fig.48 - SCREWING THE WALLS INTO THE BASE





Fig. 49 - CUTTING THE FIRST RIB

7.5 CUTTING THE CURVES

After attaching the two walls to the base, the next step was to make the curves that connect to both walls and play a key role in obtaining the desired shape of the mould. The first step of this stage was to reuse the paper template to trace its arcs on two pieces of plywood. Cutting along those lines yielded the negative of the larger curve, and the correct piece for the smaller one. Using the negative of the large curve, we traced all of the other pieces required for said curve. (Fig. 49)

Once we had marked and outlined all of the pieces, they went through the same cutting process that was implemented previously. Each curve would be supported by four "ribs". (Fig. 50 and Fig. 51)



Fig. 52 - BENDING THE PLYWOOD SHEET ALONG THE TOP RIB

Once we have gathered the ribs for each curve, the next step was to spread the thin plywood sheet on each curve. To make this process happen we took the thin plywood sheet, positioned it perpendicular to the floor, and then bent the plywood sheet along the rib's curve by applying pressure using our hands. (Fig. 52)

After we had secured the rib on the top side of the plywood sheet, one of us would staple the plywood sheet to the rib covering the entire extent of the arc. (Fig. 53)

Once the top part of the plywood sheet was fixed onto the rib, the same process was implemented for the bottom side to achieve the desired curve from top to bottom. (Fig. 54)



Fig. 50 - CUTTING THE RIB



Fig.51 - CUTTING THE RIB

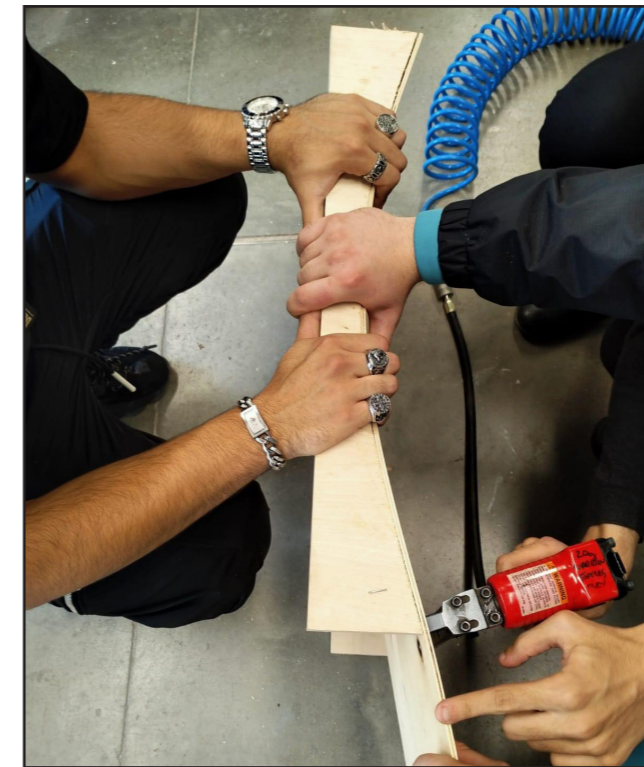

Fig. 53 - STAPLING THE TOP SIDE OF THE PLYWOOD SHEET



Fig.54 - BACK VIEW OF THE LARGE CURVE SHOWING THE TOP AND BOTTOM RIBS





Fig. 55 - BACK VIEW OF THE FOUR RIBS MAKING THE CURVE

After the top and bottom sides of the plywood sheet were fixed with the use of a pneumatic stapler, we repeated the same process for the two ribs that were located in the middle of the plywood sheet. They helped maintain the curve throughout the sheet and reinforced the piece, which was crucial for the casting process. (Fig. 55)

Once the wall that would shape the large curve was completed, we made the decision to screw three pieces of MDF on the exterior side of the curve, being attached to each rib to further avoid any damage to the mould during the casting process. (Fig. 56 and Fig. 57)



Fig. 58 - THE SMALL CURVE RIBS

The same method was utilised for the smaller curve, excluding the reinforcement treatment used previously for the large curve. (Fig. 58) The reasons for this were that these ribs were less likely to break than their larger counterparts, both due to their size and shape, and also because we needed to have access to the plywood sheet from both sides in order to screw the two timber blocks from the outside. (Fig. 59 and Fig. 60)



Fig. 56 - SCREWING THE REINFORCEMENT SYSTEM



Fig. 57 - FINALISING THE REINFORCEMENT SYSTEM

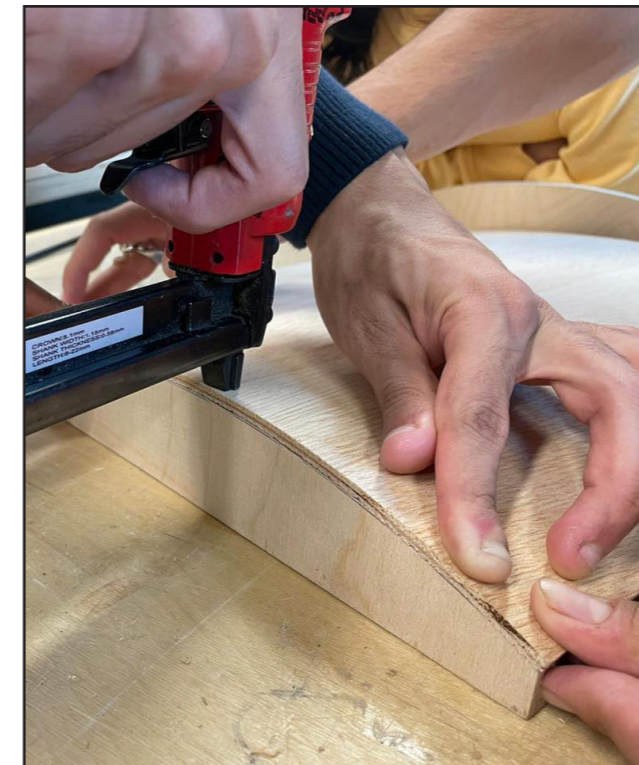

Fig. 59 - STAPLING THE CURVE

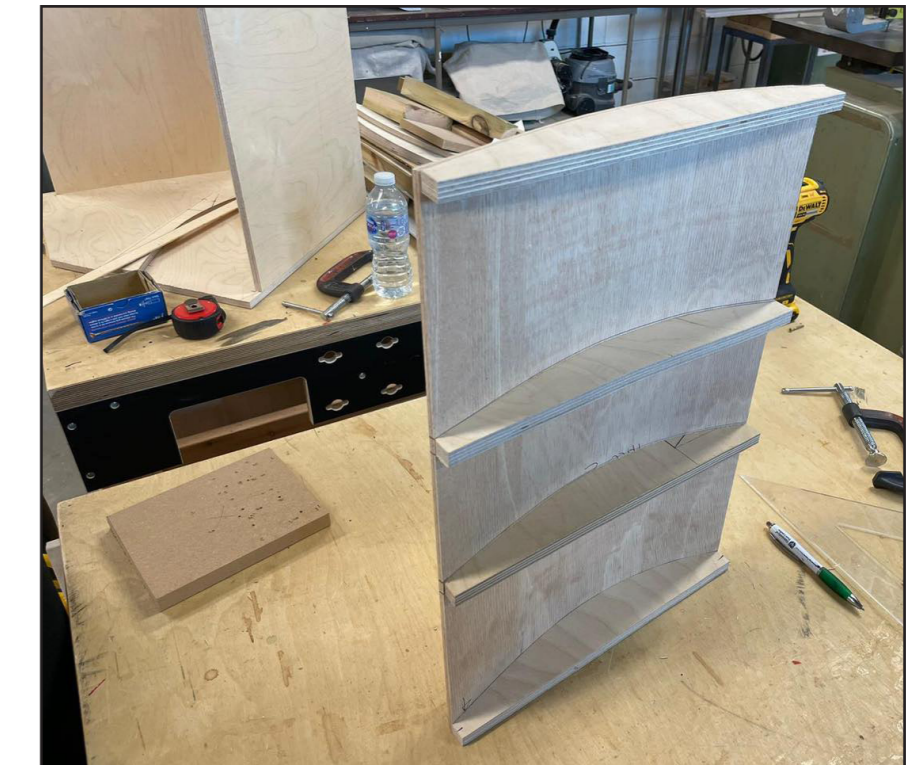

Fig. 60 - THE SMALL CURVED WALL





Fig. 61 - SCREWING THE BATTENS INTO THE WALL

#### 7.6 BRACING THE MOULD

With each side of the mould now built, the next stage was to introduce a pair of hardwood battens located on each outer edge of the mould to reinforce all the joints. For the straight walls, we cut pieces to match the height of the mould and screwed them vertically along the edges of the boards. (Fig. 61)

For the curved walls however, we calculated the angle the battens needed to be cut at and adjusted the band saw accordingly. (Fig. 62 and Fig. 63)



Fig. 64 - A CLOSE-UP OF THE BATTENS ALIGNED

Before screwing the angled battens to their respective attachment points, we aligned everything once again to make sure the fitment of the elements was pristine. (Fig. 64)

Once everything fit into place, the angled battens were screwed to their respective walls, following the orientation of the curve. (Fig. 65)

With all the battens attached to the walls, now the only thing left to do was to attach them to each other. (Fig. 66)



Fig. 62 - CUTTING THE THE BATTENS TO THE RIGHT LENGHT



Fig. 63 - CUTTING THE BATTENS AT AN ANGLE



Fig. 65 - SCREWING THE BATTEN INTO THE RIBS



Fig. 66 - ALIGNING THE PARTS BEFORE SCREWING THEM TOGETHER





Fig.67 - ATTACHING THE LEGS

7.7 LEGS

Before completely joining the four sides of the mould, we started thinking about how the mould would be transported once the casting process had concluded. We added three legs to each base we produced. This provided a better grip of the mold when moving it, especially once the casting process was complete. (Fig. 67 and Fig. 68)  
 In total, we assembled two moulds and eight bases, one for each cast piece. (Fig. 69)

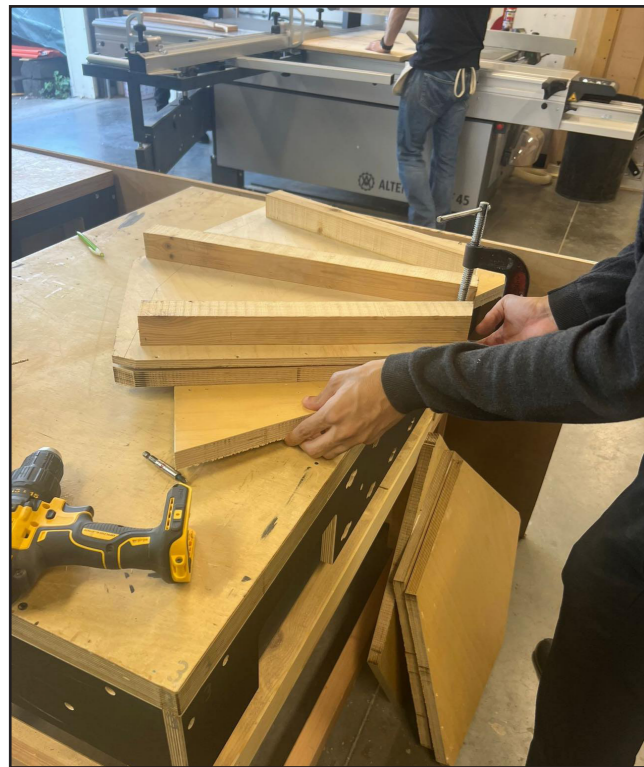

Fig.68 - MAKING BASES



Fig.69 - THE BASES

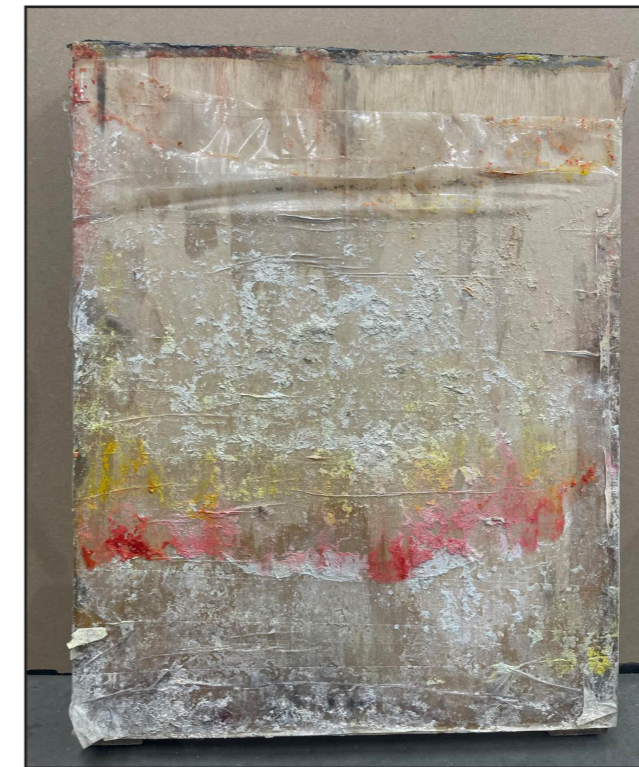

Fig. 70 - WALL WRAPPED WITH TAPE

7.8 TAPING THE INTERIOR

Before assembling the moulds, in order to avoid the Sugarcrete sticking to the walls and base of the mould, we would tape each piece that would be in direct contact with the mixture. Only the sides that would be in contact with the Sugarcrete mix were taped in order to minimise using excess materials. We taped each interior side of the mould individually, so that once assembled, it would leave no exposed timber on the inside edges. (Fig. 70, Fig. 71, Fig. 72)

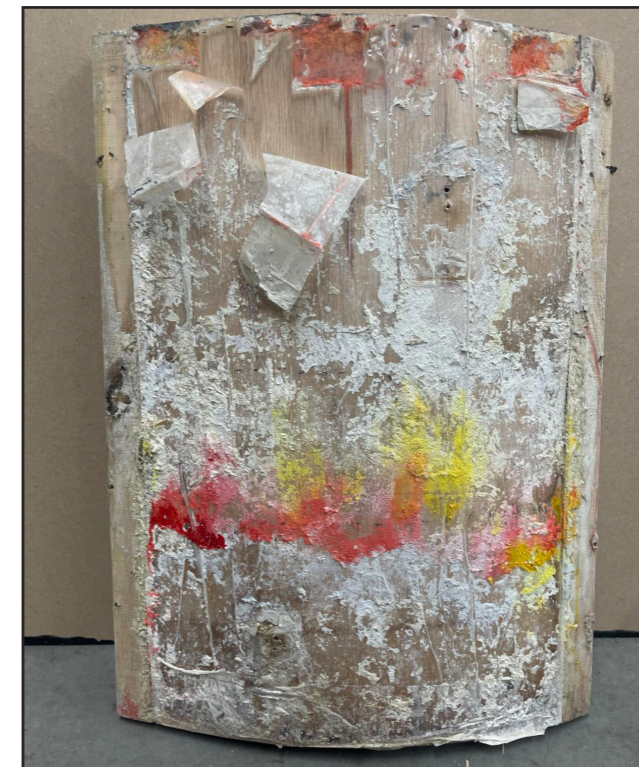

Fig. 71 - SMALL CURVE WRAPPED WITH TAPE



Fig. 72 - LARGE CURVE WRAPPED WITH CURVE





Fig. 73 - MAKING SURE EVERYTHING IS ALIGNED

7.9 FITMENT AND ASSEMBLY

After having all the elements of the mould sealed against the mixture, we were finally ready to assemble all of the elements. The two straight walls were screwed into the the base from the bottom side, followed by the two curved walls. (Fig. 73)  
 We screwed the battens with just one screw each to allow leeway for the top reference to slide into position. (Fig. 74)  
 Once everything fit nicely and was aligned as intended, we screwed the rest of the screws and removed the top. (Fig. 75)



Fig. 74 - SCREWING THE PARTS TOGETHER



Fig.75 - FINALISING THE ASSEMBLY PROCESS

7.10 FINAL RESULT











Fig.76 - SUGARCRETE



Fig.77 - BAGASSE

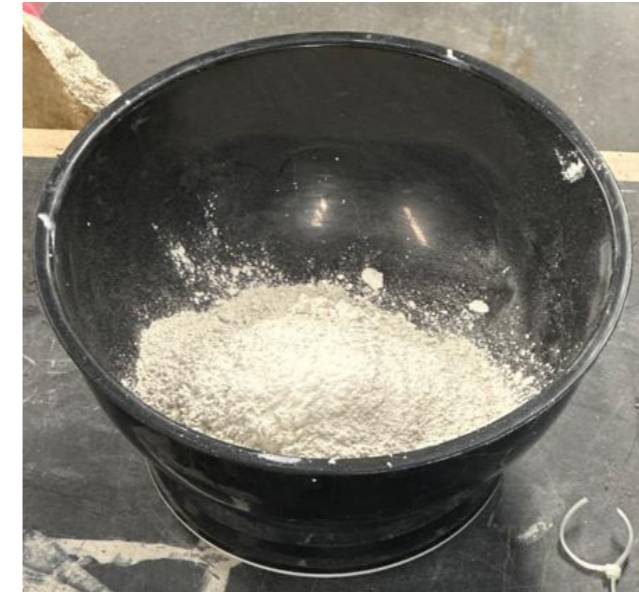

Fig.78 - LIME



Fig.79 - CEMENT

## 8.0 MIXING AND CASTING

8.1 Materials The Sugarcrete that we were working to create is achieved by mixing bagasse, lime, and water.

Bagasse is a byproduct of sugarcane after the sugary sap is extracted from them, what is left is then dried as much as possible and the end result is the fibrous material we refer to as bagasse. Not only does it alone make Sugarcrete much less brittle than the mixture without bagasse, but it also is a material that would otherwise be discarded as its production is far greater than its current usage.

The lime we use in the mixture is known as hydrated lime or calcium hydroxide. On its own, when mixed with water, its consistency becomes akin to dough, but when this doughy paste is exposed to air over time, an exothermic reaction occurs where the hydroxide molecules bond with the oxygen in the air and evaporate or leak away as water, leaving only calcium. Calcium tends to be brittle so the addition of bagasse makes what is now Sugarcrete, a more ecologically conscious alternative to concrete and mortar. The mixture ratio is one part bagasse, three parts lime, two parts water, all calculated by weight. This mixture would usually take from three days up to a week to harden, and from three weeks up to a month to cure.

Because we did not have the luxury of time, we adjusted the formula to incorporate cement which would speed up the curing and hardening process significantly. Thus, the proportions were changed. Where we previously were to use three parts lime, we used two parts lime and one part cement. This mixture would yield a result that can be removed from the mould within 5 hours of it being cast. When working with these materials, it is important to be protected. The PPE required for this task is protective goggles, respiratory/dust masks, rubber gloves, and photoreflexive vests.





Fig.80 - MEASURING THE INGREDIENTS

**8.2 Measuring** The first step of our mixing process was to measure the dosages of materials that we use in order to have the properties of our mixture be consistent across the batches that utilise the same mixture. We used a digital scale to measure the weights of each material while adding it to the same bucket. The use of a digital scale was crucial because it facilitated the nullification of the weight of the bucket, thus the scale would only calculate the weight of the materials in the bucket itself. One important thing to note is that the bagasse which we were provided would occasionally contain clumps formed by excess moisture and compression of the material. Those clumps would need to be unraveled before they were added to the bucket. This would also be the stage where we added dye to the materials if the batch were to be coloured.



Fig.81 - A DEMONSTRATION OF MEASURING AND MIXING



Fig.82 - DRY MIXING

**8.3 Dry Mixing** After gathering all the materials into a single bucket, before adding water, the next step of the process would be to mix everything until the lime and cement created a uniform coating all around the bagasse. This process would require extensive mixing by hand and constant inspections to make sure the mixture was uniform throughout the entire bucket. Occasionally, during these inspections, one would find more bagasse that would need to be unraveled. This process was arguably the most time-consuming, therefore we experimented with different mixing methods and arrangements to try to speed up the process without sacrificing the quality of the mixture. We experimented with the order of the addition of the materials as well, this would yield different results as usually the material that is added first gets compressed by the subsequent addition of the rest of the materials, making it more difficult to work with.





Fig.83 - WET MIXING

**8.4 Wet Mixing** After the mixture of bagasse, lime, and cement is adequately and evenly mixed throughout, the next step would be to add water and mix it with the dry materials. This process is similar in many ways to the previous step in terms of difficulty and time consumption. One has to again look out for areas that are not mixed well or at all, which in both mixing scenarios would end up being in the very middle or the bottom rim of the bucket.

Initially, we doubled the dosages for every bucket we mixed hoping that this would speed up the process but it ended up being a detriment more than anything. The reasons for that would be that the large amount of materials was more difficult to mix, causing the process to take longer than it would if we were to mix two regular batches separately, furthermore, the possibility that the mixtures would not be mixed well were drastically increased, which resulted in inconsistencies between batches. This led us to the conclusion that increasing the batches' size, does not equate to quicker production.

The use of water was another thing that required experimentation. The ratio provided for the water was more of a guide than an actual concrete measurement. The reasons for that are several variables. Different brands of the same materials may react in different ways when they come in contact with water. There is also the issue with the bagasse. The one that we used initially was not as dry as expected, therefore, the mixture required less water, but when we used the Indian bagasse, which was more dry, we had to use more water to achieve the same consistency and plasticity of the Sugarcrete as we did before.



Fig.84 - The void and blocks inside the mould

**8.5 Preparation for Casting**

The bucket now contained wet Sugarcrete mix, its contents were ready to be poured into the mould, however the mould required some preparation for it to start accepting the Sugarcrete mixture.

Firstly, the trapezoid prism timber blocks, which are used as anchor points for the segments to be screwed to a metal brace together, had to be screwed into the mould first. There were two moulds we used and they each had a different configuration for those blocks because the connection points would be on the top right and bottom left side for one piece, but on the top left and bottom right for the ones directly adjacent to it. The positions of the blocks needed to be uniform but we had to make sure they did not stray too much toward the edges of the cast, otherwise its structural stability and soundness would be compromised.

Another step that needed to be done before we started pouring the wet mix was to add an object(s) to fill the space faster and make the cast lighter without compromising making any point in the piece weaker than it should be. The objects that we used varied in consistency, size, and weight, but they can mainly be divided into two categories: removable and permanent. The foam was mainly used to create a trapezoid prism piece that would later be removed from the bottom of one of the cast pieces. The pieces of foam that we had in excess, but not enough to make a second piece like the aforementioned one, along with waste material generated from our work process, such as empty bags of materials, excess pieces of timber, etc. would be used for the same purpose but while casting the piece.





Fig.85 - COATING THE WALLS



Fig.86 - A COLOURED MIXTURE

8.6 Colours We wanted every segment to have a unique pattern on the front, embodying the spirit of butterfly wings. To achieve this idea, we used fabric dye in our Sugarcrete mixes, and even coated the edges of the mould in acrylic paint to have that coat be absorbed by the material. Initially we had planned for a specific intertwining and continuous pattern to be cast but because of the fact that we would need to compress every layer we add, it would not be a viable option as we would not be able to correctly determine the quantity and positioning of every chunk of the mixture. Therefore, we opted for an entirely random combination of colours and patterns. We were practically experimenting with the colours as we were using them for the segments. We even made use of different materials, such as bagasse ash, to achieve new colour combinations. To minimise the usage of dye, we only had the edges of the cast be coloured, be it using coloured mixtures or painting the inside walls of the mould.

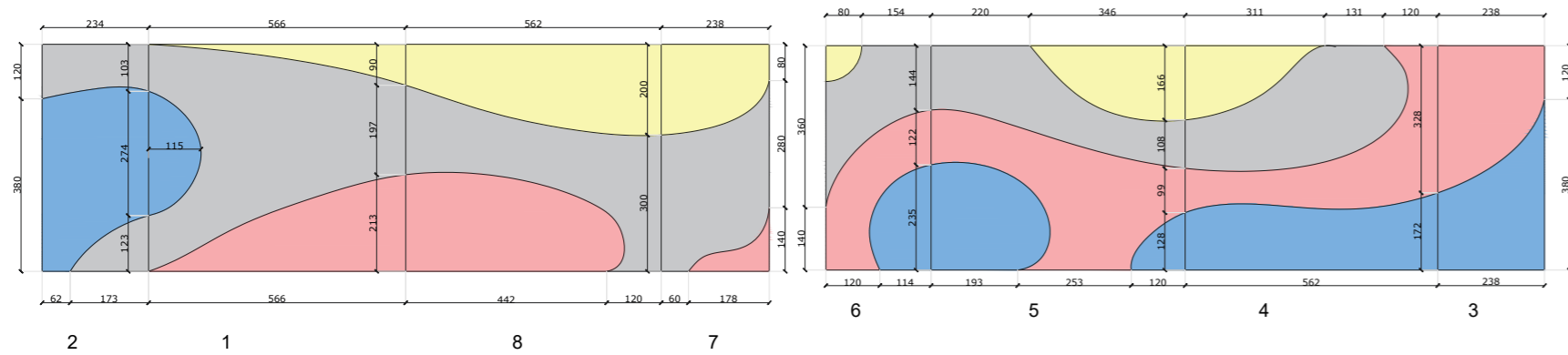

Fig.87 - THE INITIAL PATTERN DESIGN

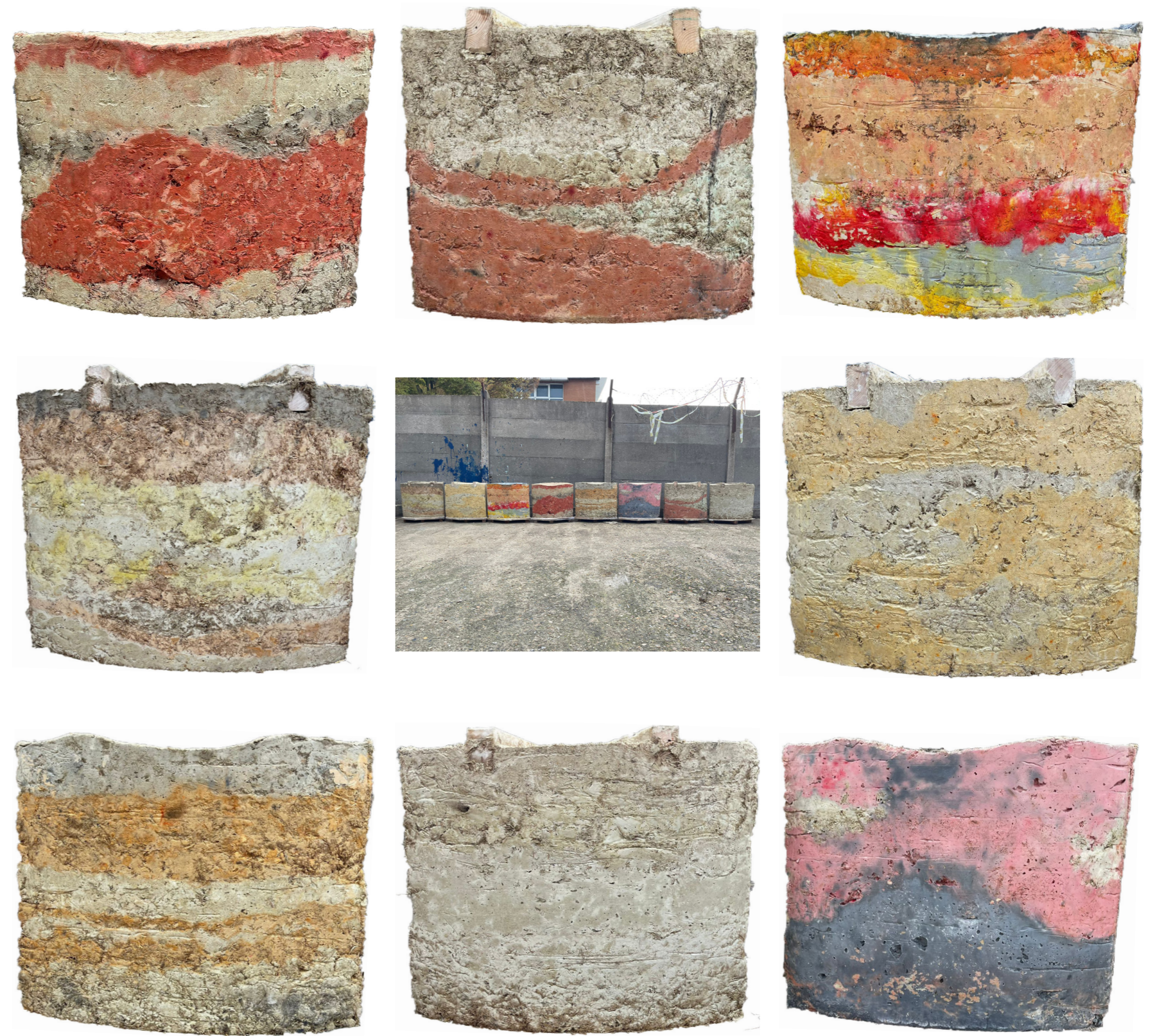





Fig.88 - POURING THE MIX



Fig.89 - COMPRESSING THE SUGARCRETE

#### 8.7 Pouring and Compression

This is the step where we would start pouring the mix into the mould. We would create a layer of roughly 10cm before compressing it. If we wanted to add colour to the facade of the piece, we would do so only in the front because that is the only side it would be visible from, therefore, we would not have to waste any coloured Sugarcrete mix. The waste material that we had and any leftovers from cutting were all cast at various points into the piece itself with no plan for them to be removed. This ends up being beneficial in many ways, both for us and the environment. When compressing the Sugarcrete, we had to be extremely aware of the positions of the timber blocks so we avoid damaging them and the mould due to the force exerted when compressing, but also to make sure that the material has fully and properly enveloped them so that they end up properly secured to the cast and we do not risk the piece breaking under tension from the timber blocks being connected.

After the mould was filled, we used a guide to help us create a specifically calculated slope at the top so the rain would not collect there and would slide off instead. At this point, all we had to do was to either move the mould with the Sugarcrete in it to a sheltered space, or to just cover it so that the rain does not impede the curing process. In total, we used the equivalent of 11 bags of bagasse, 6 bags of white cement, and 13 bags of lime.

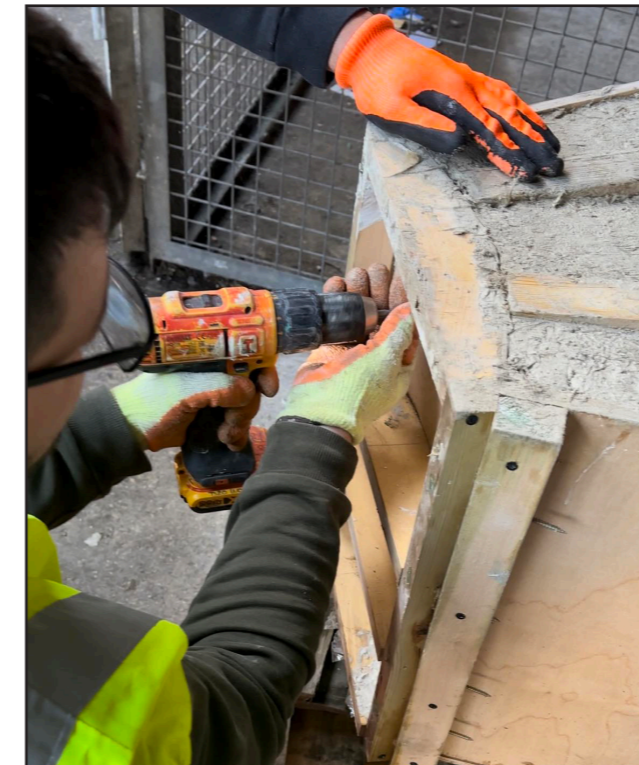

Fig.90 - UNSCREWING THE SMALL CURVE FROM THE BLOCKS



Fig. 91 - UNSCREWING THE CURVES

## 9.0 DEMOULDING AND REASSEMBLY

#### 9.1 REMOVING THE MOULD

After the cast is firm enough to sustain its own weight, we started to unscrew the main elements of our mold one by one. First we started by removing the screws from the timber blocks from the back side of the mould and the two timber pieces on the top side of the cast. (Fig. 90) For the next step, we had to unscrew the curves because they are not secured to the base unlike the two straight walls, after which we were able to unscrew the walls themselves. (Fig. 91) Once we removed all the sides of the mould we would finally have our cast segment, which would then subsequently be moved to a safe place devoid of rain. (Fig. 92)



Fig. 92 - UNSCREWING THE WALLS FROM THE BASE



VIEW OF THE FIRST  
CAST



FRONT OF THE FIRST  
CAST





BACK OF THE FIRST  
CAST



Fig. 93 - NEW BASE



Fig. 94 - ATTACHING THE WALLS

9.2 REASSEMBLY

After we moved our cast to a safe place, we would take a fresh base and start rebuilding our mould following the same steps that were implemented previously. (Fig. 93)  
We also made use of the base template again and top reference to obtain perpendicular walls and accurate proportions for the every following cast segment. (Fig. 94 and Fig. 95)

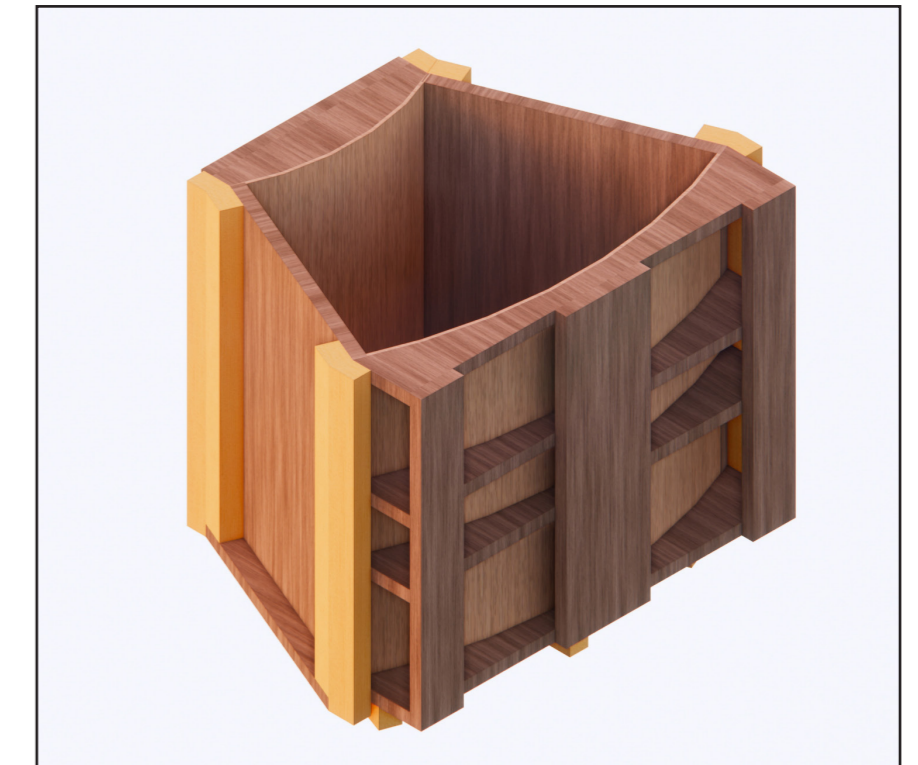

Fig. 95 - ADDING THE CURVES



## 10.0 FINAL OUTCOME

After refining the module pieces and filling any cavities that may need to be filled, we would have to add metal braces and connect them via the blocks that were cast on the smaller curved side of the segments. After that the next step is to measure, cut, sand, and varnish the timber planks that will be used for the seating, after which they will be screwed onto the wooden pieces cast on the top of half of the segments.

With all the segments connected we are left with a donut shape. To fill the void inside we have planned for a planter to be installed in the middle, soil would be poured into it, and seeds would be planted into the soil.

The final product is a practical installation, the design of which can be adapted for use in other environments and scenarios. The versatility of the configurations that can be created using this modular design is practically limitless.









# 11.0 REFLECTIONS



Fig.93 - THE FIRST BATCH OF INGREDIENTS



Fig.94 - THE SECOND BATCH OF INGREDIENTS

The overall timeframe from brief to reality was four weeks. There were several causes for the project to be delayed:

1. There was a shortage of materials for the mould, therefore we had to disassemble old furniture to extract more materials from them, and if that would not satisfy our needs, we would have to purchase some extra materials ourselves.
  2. The site where we were supposed to mix and cast temporarily had no access to water, therefore we had to be on standby until the issue had been resolved.
  3. We also stumbled upon another material shortage, this time pertaining to the cast itself. Due to that, we were forced to halt production until we were supplied with more materials to work with.
  4. Due to the bagasse that was provided to us being flown all the way from Belize, when we were starting to run out of it, we had no means of acquiring some more as it would be too costly, time consuming, and it would cause high carbon emissions. The workarounds we managed to come up with were:
    - A. Using a smaller dosage of bagasse in the mixture.
    - B. Using bagasse ash, either mixed with the bagasse, or completely replacing it.
    - C. Using Indian bagasse, which has a different consistency to the one used previously.
    - D. Mixing the Indian bagasse with the bagasse ash.
- We casted two sample blocks of Sugarcrete, one using Indian bagasse, and the other one using bagasse ash. They will be put through various tests so that we have an accurate comparison statistic.
- Due to the time constraints, we adjusted our mixture to include cement so that the cast pieces cure much quicker.

Which Activities Carry Risk?								
Hazard / Activity Involved	Describe the potential risk?	Who is at risk?	Likelihood of risk	Severity of risk	Risk Rating (Likelihood x Severity)	What precautions have been taken to reduce the risk?	What further action is needed to reduce risk (By whom and by when?)	Review Date
Cutting the wood	Moderate, Slight injury	Whoever is involved in the activity	1	2	3	We need to wear protective gloves, safety goggles, apron and steel-toed boots.	If any moderate or slight injury happened then we have to seek first aid from the technician (Daryl Brown/ David Morgan).	05/10/2023
Screwing the wood	Moderate, Slight injury	Whoever is involved in the activity	1	2	3	We need to wear protective gloves, safety goggles, apron and steel-toed boots.	If any moderate or slight injury happened then we have to seek first aid from the technician (Daryl Brown/ David Morgan).	05/10/2023
Mixing the Sugarcrete	Moderate, Slight injury	Whoever is involved in the activity	2	2	4	We need to wear protective rubber gloves, safety goggles, apron and face mask.	If too much lime is inhaled it is necessary to call the paramedics. If lime gets in contact with the skin, disinfect and wash thoroughly.	05/10/2023







# Over The Tracks

Outdoor Sugarcrete Furniture

CONSTRUCTION WEEK 2023  
UNIVERSITY OF EAST LONDON

Sinan Abdulaymi  
Francesco Stefan  
Cristian Severin  
Shushant Jadhav  
Twinkle Shah  
Jason Tshibangu

06.11.2023

If you think you  
can complete the  
report on  
time...

You  
are  
dead  
wrong!!!